

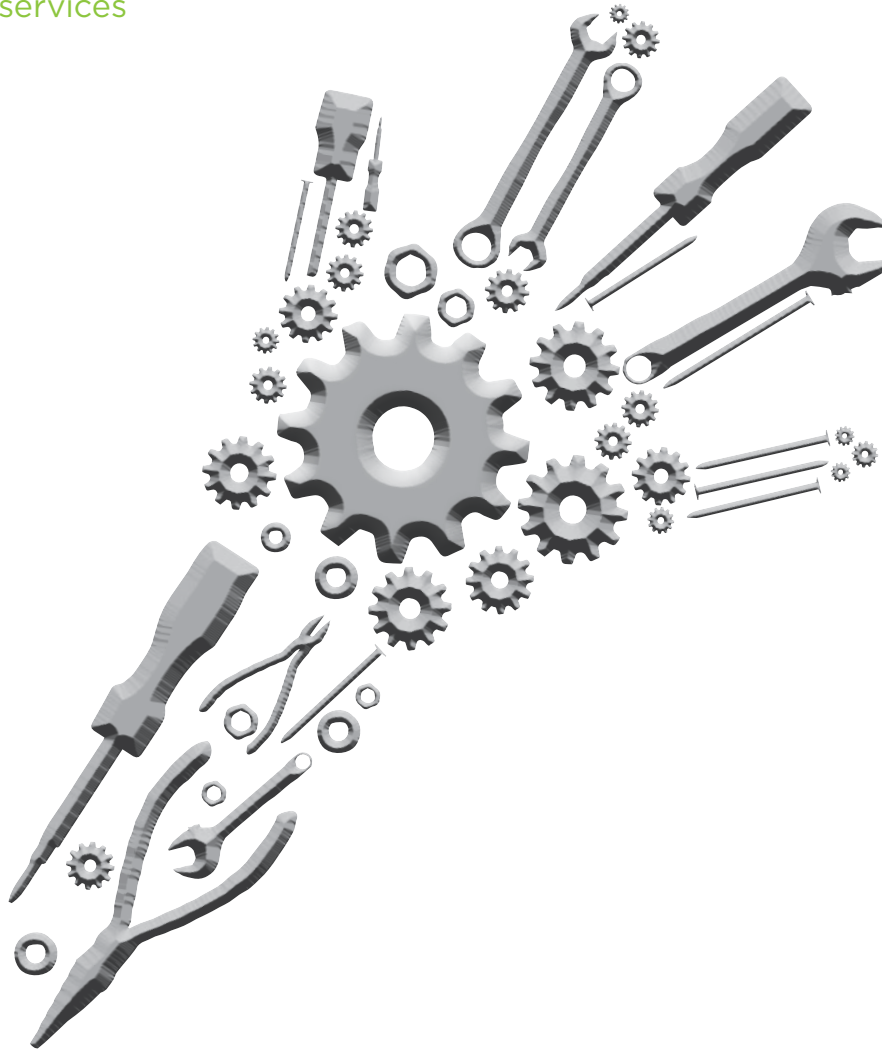

U&L equipment

EQUIPMENT PRODUCT GUIDE



SERVICE AT YOUR FINGER TIPS

Is your equipment in need of servicing?

Is your annual audit around the corner?

- Our team has the specialised equipment and software required to service/calibrate and repair your equipment to the manufacturers' recommendations.
- We service, calibrate and repair to AS/NZS3551 standards.
- All our technicians have been certified by the manufacturers to calibrate, service and electrically safety check your equipment.
- Competitively priced, quality workmanship and customer focused.

WelchAllyn

USL Medical is the only authorised service provider for Welch Allyn warranty products in New Zealand.

Please give us a call on **0800 265 218**
for a quote or to book in a service

AUTOCLAVES	5
Melag® Autoclaves	6
Melag® Autoclave Accessories.....	7
BEDS	9
Bed Movers Single and Double Tine.....	10
ICU/HDU.....	11
Ward Bed	12
Maternity/Delivery	14
Aged Care.....	15
Treatment Tables.....	16
Stretchers.....	24
Paediatric	25
CASTING	26
Plaster Removal.....	27
DIAGNOSTICS	29
Monitoring	30
Monitoring Accessories	34
Cuff guide.....	35
Blood Pressure Management.....	36
Disposable Cuffs	40
Sphygmomanometers	43
Stethoscopes.....	44
Diagnostic Sets	47
Otoscope Heads	52
Otoscope Heads and Accessories	54
Diagnostic Handles and Thermometry	55
Headlights, Episcopes and Dermatoscope... ..	58
Womens Health.....	60
Lights.....	62
Cardiopulmonary Products.....	64
ECG	65
ECG Accessories and Connectivity.....	66
Laryngoscopes	69
Led Upgrades	70
Lamp and Battery Guide.....	71
Ear Testing Instrument.....	72

HUNTLEIGH CTG MONITORS	73
DOPPLERS AND ACCESSORIES	77
EAGLE FIXED AND MOBILE SHELVING	83
MEDICAL & SURGICAL CARTS/TROLLEYS 85	
HOISTS	89
Mobile	90
Hoists and Patient Transfers.....	91
Slings	96
MATTRESSES	113
MIDMARK SPECIALTY TREATMENT CHAIRS	121
REUSEABLE TEXTILES	123
Bed Pads & Chair Pads	124
Clothing Protectors & Patient Gowns	126
Laundry Bags & Carts	127
Sheets & Bedspreads.....	128
Bath Towels, Hand Towels & Face Cloths ...	129
Slidesheets	130
CHATTANOOGA ELECTROTHERAPY	131
WEINMANN EMERGENCY	137
Ventilation	138
Defibrillator & Monitoring	142
Resuscitators & Suction.....	146
WEINMANN HOMECARE	150
Sleep Diagnostics	151
Sleep Therapy	152
Patient Interface	159
Oxygen Medicine	163



MELAG® AUTOCLAVES



MELAG AUTOCLAVES* INCLUDE:

- S - Class
- B - Class
- Premium Plus Class
- Pro Class
- Large Autoclaves

OTHER SERVICES INCLUDE:

- Cleaning/Disinfection
- Documentation
- Water Treatment
- Packaging

**FOR MORE INFORMATION CONTACT:
USL MEDICAL CUSTOMER SERVICES ON 0800 658 814**

MELAG AUTOCLAVES

Fifty years ago, MELAG began in Berlin to specialise in the manufacture of sterilisation equipment. Quality consciousness, reliability, and innovative eagerness, plus the highest in safety standards, have by now made the family-run enterprise MELAG one of the world's leading producers of sterilisation equipment.

The company's success is verified by the sale of more than 400,000 units. Decades of experience, state-of-the-art computer-controlled production technology, the application of high grade materials and an experienced and qualified workforce make MELAG devices easy-to-use quality products.

The company philosophy emphasises the systematic focus on one restricted production program. With its highly specialised development team, it is thereby possible for MELAG to keep and further develop its product line market-driven and on an international leading technical level.

The entire MELAG staff is proud to be making an important contribution to the protection of the health of patients and medical staff with the equipment and accessories it produces for the safe sterilisation and storage of sterilised articles.



DATA STORAGE



CF Card (1071)
All cycle data can be automatically written on the CF card and directly read into any PC.



Melaflash (1067)
The MELAflash system consists of a compact flash card printer, the MELAflash CF card and the MELAflash card reader.



MELACONTROL® (8510)

Process challenge device according EN 867-5 for testing the function of a "Class B" autoclave.

What is MELAcontrol®

MELAcontrol® is a process challenge control and indicator system consisting of a test body, the so-called "helix" and the MELAcontrol® test strips. MELAcontrol® is designed for the simulation of difficult sterilisation conditions, ie of long and narrow-bore instruments that are designated as "Hollow A" in European Standard EN 13060. MELAcontrol® conforms to European Standard EN 867-5: 2001 and is only useful for "Class B" autoclaves.

What does MELAcontrol® offer

MELAcontrol® offers you the possibility, with a minimum of time and expense, of periodically and cost-effectively confirming in your surgery or hospital the performance effectiveness of your "Class B" autoclave. MELAcontrol® simulates the most difficult of all sterilisation conditions: for example, with hollow-body A instruments. Its effectiveness results from its capsule with an indicator strip only at the end of a long, narrow-bore tube. If this process challenge control system has been successfully sterilised - as shown by the change in colour of the MELAcontrol® indicator - then you can assume that the entire charge has been successfully sterilised.

Simple application

The test strip is located in the removable cap of the MELAcontrol® test body, the so-called "helix". When saturated steam acts sufficiently long on the helix, it shows a colour change. A new test strip is used for every test with MELAcontrol®. The items included in delivery of the MELAcontrol® are the test body (helix), and 250 test strips.



MELADEM® 40

Quality assurance for sterilisation

MELAdem® 40 supplies high-quality demineralised water for the steam generation in an autoclave. The MELAdem® 40 can be directly connected to the MELAG Europe autoclaves Vacuklav® and Euroklav® to automatically feed high quality demineralised water for each sterilisation cycle. Of course, you can also use the MELAdem® 40 anywhere else for any application requiring good water quality.

Installation

MELAdem® 40 can be installed directly to a Vacuklav®, Vacuquick® or Euroklav®. MELAdem® 40 can also be mounted on the wall, or can be simply placed in a sub cabinet. It is attached directly to the tap-water line, and is immediately ready for use after connection to a normal tap-water line.

FOR MORE INFORMATION CONTACT:

USL MEDICAL CUSTOMER SERVICES ON 0800 658 814

TECHNICAL DATA	MELADEM® 40
Housing	32cm x 35cm x 15cm
Weight (filled with resin)	2.4kg
Max water pressure	10 bar
Quality of the produced water	1 - 5 S/cm
Bacteriological quality	Pure water
Possible yield of one filling for 600 S/cm tap water quality	120 litres
Resin (2 cartridges)	Order No. 61026



BEDS

- BED MOVER
- ICU/HDU
- WARD
- MATERNITY/DELIVERY
- AGED CARE
- TREATMENT TABLES
- STRETCHERS
- PAEDIATRIC



Typical Applications

- Compatible with almost all hospital beds
- Moving hospital beds with or without patients
- Between rooms and wards
- No under-bed clearance required
- Emergency stretchers
- Trolleys
- ICU column beds (e.g. Care Assist)
- Floor beds Low Low

Features

- Capacity: 600kg (standard model) & 800kg (bariatric model)
- Move bed with or without patients safely and efficiently
- Push button hitching – silent, fast and efficient
- Non marking tyres suitable for indoor use
- Quiet, smooth operation with zero emissions
- Simple to use, no driver's licence required
- Comprehensive 12 month warranty

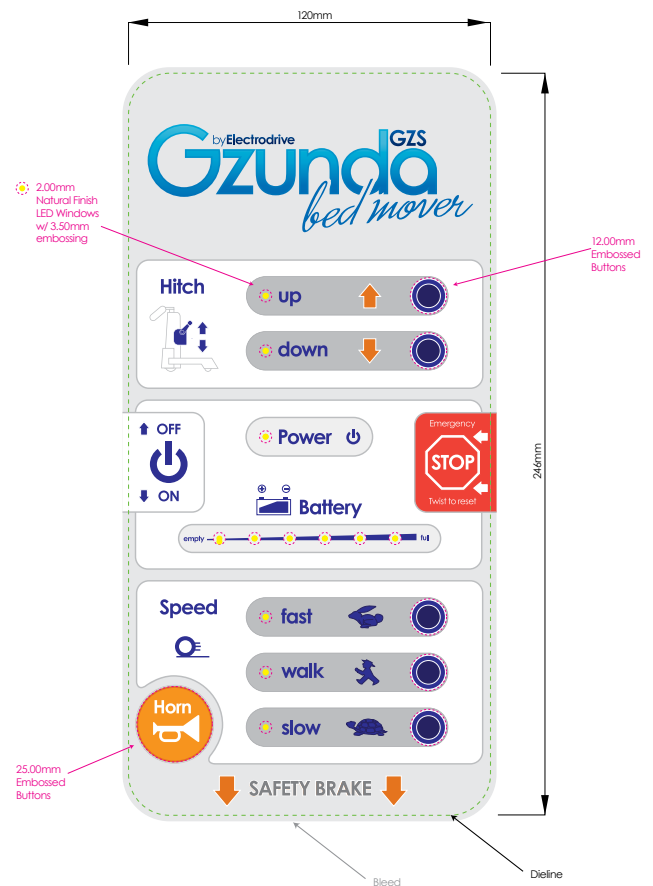



PROGRESSA™ - ICU BED SYSTEM

Frame + High End Dynamic Surface:

Features:

- Air Pressure Relief, heel suspension, pulmonary-ready
- Turn Assist
- Opti-Rest
- GCI Colour touch screen
- Therapy statistics
- Head and Intermediate siderails
- Headboard and footboard
- Radiolucent Head Section
- Central Brake and steer on all four castors
- HandsFree® Emergency CPR and Trendelenburg release mechanism
- Electric Trendelenburg
- non-powered hydraulic foot pump frame articulation
- Line of Site® Angle indicator for Head elevation and Trendelenburg, FlexAfoot™ Retractable foot control
- FullChair® for patient egress position
- Cradle Transition
- Line Manager
- TuckAway™ siderails
- Line-of-Site® Angle indicators
- Point-of-Care® siderail controls
- One button Boost™ feature ,PMMS - Patient Migration Monitoring System
- Patient controls (siderail embedded)
- OneStep® Siderail Release
- Night light, drainage bag holders
- Wallguard® Roller Bumper System and roller bumpers
- 6"PU casters, audible brake off alarm
- Integrated Scale.
- Max Patient Weight - 227kg. SWL 295kg
- IntelliDrive - Inbuilt bed mover.
- Various Models available.



VERSACARE

A.I.R.™ (active integrated response™) Pressure relief system with turn assist and max inflate or a Foam Mattress (NP200S PG)

Features:

- Integrated Air Pressure Surface options (Mattress)
- X-ray Sleeve
- Turn assist
- Enhanced turn assist (P500)
- Foam surface
- LowChair™ position
- 4-corner brake/neutral/steer pedals
- Handsfree® foot controls for head and bed height
- Tuckaway™ head and intermediate siderails with Point-of-Care® controls
- Stationary height headboard
- Footboard
- Emergency CPR and Trendelenburg release mechanism
- FlexAfoot™ retractable foot control
- Line-of-Site® angle indicators
- Patient controls back lighting
- Drainage bag holders
- Available battery power
- Night light
- Four IV sockets and an IV rod
- 5" Tente castors
- Headboards and footboards available in light neutral only
- In bed scale and PPM option
- IntelliDrive - inbuilt bed mover (option)
- Max patient weight 227kg
- SWL 227kg

**FOR MORE INFORMATION CONTACT:
USL MEDICAL CUSTOMER SERVICES ON 0800 658 814**

Hill-Rom



CARE ASSIST ES - WARD BED

Electric profiling bed with adjustable height, head, and knee, with powered Trendelenburg and Reverse Trendelenburg.

Features:

- Integrated caregiver controls
- Patient integrated pendant controls with bed movement lock-outs
- One-button dining chair™ position,
- Sheerless pivot®
- Autocontour
- Battery back-up
- Central brake and steer
- Four dual-locking castors
- Integrated bed extender
- Brake-off alarm
- Line-of-Site® angle indicators for head section and Trendelenburg position
- Head and foot boards are removable
- Patient Positioning Management
- In bed weigh scale options
- SWL 227kg



HR900 - SSR - WARD BED

With Split Siderails with integrated controls.

Features:

- Electric variable height
- Electric sliding backrest
- Electric thigh section
- Manually adjustable foot section
- Caregiver and patient control pendant
- Intelligent auto contour™
- Patient Egress position
- Bilateral emergency CPR control
- Nurse control panel on patient right side, with function Lockouts
- Lowest safety height indicator
- Line-of-site™ backrest indicator
- 4 section sleep deck with removable panels
- Adjustable mattress retainers
- Bilateral accessory holder
- 4 corner bumpers and accessory holders
- 6 patient restraint strap holders
- Moulded removable head and foot boards
- Mobile head section
- Endboard locks
- Steering wheel at head of bed
- Central braking on 4 castors
- Split siderails without integrated controls
- 150 mm castors



INNOV8 LOW BED - WARD BED

Features:

- Exceptional low-to-high range 22.5cm to 71cm
- Maximum patient weight of up to 30 Stone (190kg)
- 3 year warranty (1st year parts & labour, 2nd year parts only)
- The Innov8 Night Pack illuminates the underside of the bed improving patient safety and security
- Easy to clean and decontaminate, incorporates BioCote®
- Electrically operated backrest, height & knee break with battery backup
- 12cm under bed clearance for hoist (minimum mattress platform height 40cm)
- Auto-cardiac chair position (as per standard Innov8)
- Central locking braking system - dual sided
- Extendable mattress platform length for taller patients (+ 20cm)
- Easy to manoeuvre, reducing back or handling problems
- Removable head/foot ends with colour coding options
- IP54 standard ingress protection
- UK manufacture and support

INNOV8

CODE	DESCRIPTION
INNOV8LOWD	Innov8 Low Low Bed





AFFINITY BIRTHING BED

Features:

- Straight edge (U-Cut) mattress
- Integrated calf supports electric variable height
- Head and foot elevation
- 2 half length side rails with integrated patient controls
- Central brake and steer
- CPR
- Removable headboard
- Battery back-up
- IV Pole
- Automatic night light for patient security
- Trendelenberg manual operation of functions
- SWL 227kg

CODE	DESCRIPTION
11003	Affinity Birthing Bed

OPTIONAL EXTRA

MIP SLEEPKNIT SHEETS AFFINITY BED	
CODE	DESCRIPTION
13161	Fitted Sheet For Lower Section
13169	Fitted Sheet for Upper Section





ODEN AGED CARE BED

Features:

- X lift functionality
- Head tilt functionality
- Electric three function bed
- Electric knee break
- Central Locking 125 mm Castors
- Epoxy powder coating
- Safe Working Load 215 kg
- In built leg extension
- Wood grain Head and foot board
- Height range: 210 to 760mm
- Removable metal infection pads

ODEN AGED CARE BED	
CODE	DESCRIPTION
13651	3 section bed with central locking
14055	King single bed
AGED CARE BED	
CODE	DESCRIPTION
13692	2 section bed with individual locking castors



COU90



COU78



COU73

FIXED HEIGHT COUCH AND STEPS

- Exceptionally robust, sturdy couch with a modern look
- Unique paper roll holder supplied as standard that can be fitted either within the couch frame or externally
- Extremely reliable self locking multi-position adjustable backrest
- Unstitched, rounded upholstery corners for hygiene and cleanliness
- Simple levelling for uneven floors
- Sculptured tube frame to ease backrest lifting
- Maximum user weight 160kg (25st)
- The system allows the user to select numerous combinations of where the drawers are located
- Attractive and durable mild steel epox coated finish with BioCote®
- Complete with two drawers
- Additional drawers can be purchased

CODE	DESCRIPTION	SIZE
COU90	Fixed height couch with 2 draws	L 184mm - W 70.5mm - H 80mm
COU78	Foot Stool 2 Step	
COU73	Foot Stool 1 Step	



GYMNA G2 DUO

The G2 Duo is the basis for welcoming your clients in a comfortable and safe manner. This treatment and examination couch can be moved fully downwards to chair height so that getting on or getting off has never been easier.

The long back section supports the sitting position, so that your client can be optimally involved in the treatment.

Key Features

- Manufactured in Belgium
- Delivered with a current Electrical Safety Certificate
- Guarantee: 3 years (upholstery 1 year)

Standard features

- Two-section couch with adjustable back section
- Back section supported by gas spring
- Electric height adjustment with foot switch
- Cushions with 40mm padding
- Non slip feet
- Colour: Granite

Accessories

- USL Code: 10878 G2 Paper Roll Holder 60cm

Specifications

- Length x width: $\pm 205 \times 67$ cm
- Height adjustment: $\pm 47 - 100$ cm
- Weight: ± 85 kg
- Max. lifting capacity: 200 kg
- Power supply: 230 VAC, 50-60 Hz, 1,0 A
- 120 VAC, 60 Hz, 1,7 A
- Insulation class: II
- Moisture resistance: IP 21
- Classification: I
- Conformity: IEC/EN 60601-1
- IEC/EN 60601-2
- MDD 93/42/EEC



Electric Foot Plate



Peripheral Switch Plate



Hydraulic Foot Plate

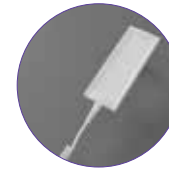

Electric Hand Switch

GYMNA G2 SERIES - DUO

CODE	DESCRIPTION	CONTROL MECHANISM	CASTORS	FACE CUSHION
10860	Gymna G2 Duo	Electric Foot Switch	Castors	Face Hole + plug
10867	Gymna G2 Duo	Electric Foot Switch	Castors	No Face Hole
10877	Gymna G2 Duo	Electric Hand Switch	Castors	Face Hole + plug
10876	Gymna G2 Duo	Electric Peripheral Switch	Castors	Face Hole + plug
13526	Gymna G2 Duo	Hydraulic Pump	Castors	Face Hole + plug
10868	Gymna G2 Duo	Electric Foot Switch	No Castors	No face Hole
11103	Gymna G2 Duo	Electric Foot Switch	No Castors	Face Hole + plug



GYMNA G2 TRIO

The all-rounder of the Gymna G2 series, the G2 Trio treatment and examination couch has an adjustable head and back section, making it the perfect solution for treatments in sitting and lying position. It is truly versatile due to its simplicity.

The G2 Trio can be equipped with armrests for optimal relaxation in the prone position.

Key Features

- Manufactured in Belgium
- Delivered with a current Electrical Safety Certificate
- Guarantee: 3 years (upholstery 1 year)

Standard features

- Three-section couch with adjustable head, and back section
- All sections supported by gas springs
- Electric height adjustment with foot switch
- Cushions with 40mm padding
- Non slip feet
- Colour: Granite

Accessories:

- USL Code 10878 G2 Paper roll holder

Specifications

- Length x width: ± 205 x 67cm
- Height adjustment: ± 47 - 100cm
- Weight: ± 80 kg
- Max. lifting capacity: 200 kg
- Electric motor: 6.000 N
- Hydraulic pump: 10.000 N
- Power supply: 230 VAC, 50-60 Hz, 1,0 A
- 120 VAC, 60 Hz, 1,7 A
- Insulation class: II
- Moisture resistance: IP 21
- Classification: I
- Conformity: IEC/EN 60601-1
- IEC/EN 60601-2
- MDD 93/42/EEC



Peripheral Switch Plate



Electric Hand Switch



Electric Foot Plate



Hydraulic Foot Plate

GYMNA G2 SERIES - TRIO

CODE	DESCRIPTION	CONTROL MECHANISM	CASTORS	FACE CUSHION
10863	Gymna G2 Trio	Electric Foot Switch	Castors	Face Hole + plug
10864	Gymna G2 Trio	Electric Foot Switch	Castors	No face Hole
10865	Gymna G2 Trio	Electric Foot Switch	No Castors	No face Hole
11104	Gymna G2 Trio	Electric Foot Switch	No Castors	Face Hole + plug
13532	Gymna G2 Trio	Hydraulic Pump	Castors	Face Hole + plug



DUO ADVANCED ELECTRIC

with castors, face hole & plug

An excellent 2-section treatment couch, with an emphasis on treatment in a seated position. Also particularly suitable as a robust base for general examination of flexion and extension functions.

Key Features

- Manufactured in Belgium
- Delivered with a current Electrical Safety Certificate
- Guarantee: 3 years (upholstery 1 year)

Standard features

- Two-section couch with adjustable back section
- Back section supported by 2 gas springs for maximum stability
- Electric or hydraulic height adjustment
- Gymna Stability Profile (GSP)
- Cushions with 40 mm padding
- Breathing hole in back incl. cushion
- Central wheel-lifting mechanism with 4 casters
- Non slip feet

Specifications

- Length x width: $\pm 202 \times 67$ cm
- Height adjustment: $\pm 45 - 95$ cm
- Weight: ± 80 kg
- Max. lifting capacity: 200 kg
- Electric motor: 6.000 N
- Hydraulic pump: 10.000 N
- Power supply: 100 - 240 VAC, 50-60 Hz
- Current consumption: 1,5 A
- Insulation class: II
- Moisture resistance: IP 21
- Classification: I
- Conformity: IEC/EN 60601-1
- IEC/EN 60601-2
- CAN/CSA C22.2 No. 601.1
- MDD 93/42/EEC

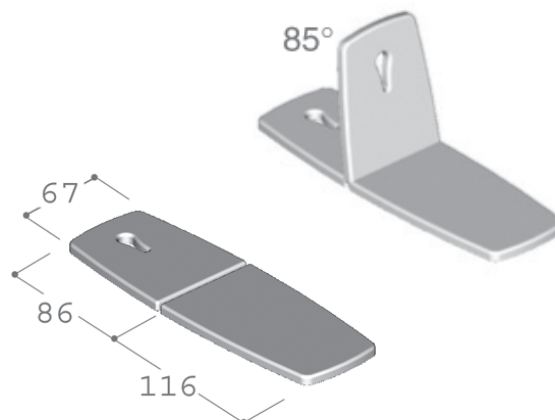

DUO ADVANCED

CODE	DESCRIPTION	CONTROL MECHANISM	CASTORS	FACE CUSHION
1155	Gymna Duo Advanced	Electric Foot Switch	Castors	Face Hole + plug



TRIOPLUS ADVANCED

A 3-section couch in the purest form stable and functional. Adjustable headrest, middle and leg section. Extremely versatile and suited for treatment in sitting, lying, lumbar flexion and Trendelenburg position. Guarantees years of problem-free support for your manipulations.

Key Features

- Manufactured in Belgium
- Delivered with a current Electrical Safety Certificate
- Guarantee: 3 years (upholstery 1 year)

Standard features

- Three-section couch with adjustable head, middle-, and leg section
- All sections gas spring supported
- Electric or hydraulic height adjustment
- Gymna Stability Profile (GSP)
- Cushions with 40 mm padding
- Breathing hole in head section, incl. cushion
- Central wheel-lifting mechanism with 4 casters
- Non slip feet
- Colour: Granite

Specifications

- Length x width: $\pm 202 \times 67$ cm
- Height adjustment: $\pm 45 - 95$ cm
- Weight: ± 97 kg
- Max. lifting capacity: 200 kg
- Electric motor: 6.000 N
- Hydraulic pump: 10.000 N
- Power supply: 100 - 240 VAC, 50-60 Hz
- Current consumption: 1,5 A
- Insulation class: II
- Moisture resistance: IP 21
- Classification: I
- Conformity: IEC/EN 60601-1
- IEC/EN 60601-2
- CAN/CSA C22.2 No. 601.1
- MDD 93/42/EEC
- Guarantee: 3 years (upholstery 1 year)

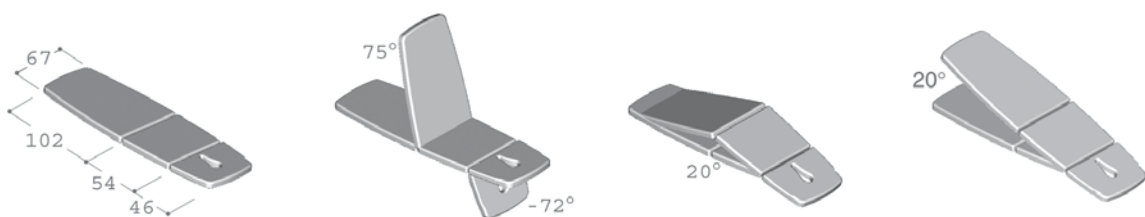

TRIO ADVANCED

CODE	DESCRIPTION	CONTROL MECHANISM	CASTORS	FACE CUSHION
1157	Gymna Trio Advanced	Electric Foot Switch	Castors	Face Hole + plug



BOBATH-2 ADVANCED

The Gymna Bobath-2 Advanced treatment and exercise couches provide ideal support for treating patients with mobility problems or dysfunctions as a result of cerebral paresis or hemi paresis.

The back support of the Bobath-2 makes this couch more universal and facilitates lying/sitting exercises.

Key Features

- Manufactured in Belgium
- Delivered with a current Electrical Safety Certificate
- Guarantee: 3 years (upholstery 1 year)

Standard features

- Two-section Bobath couch with adjustable back section
- Back section supported by 2 gas springs for maximum stability
- Extra wide support surface (120 cm) and adapted chassis
- Electric height adjustment by foot switch
- Patient hoist compatible, 15 cm clearance below chassis
- Gymna Stability Profile (GSP)
- Cushions with 40 mm padding
- Central wheel-lifting mechanism with 4 casters
- Non slip feet
- Colour: Granite

Specifications

- Length x width: $\pm 202 \times 120$ cm
- Height adjustment: $\pm 45 - 95$ cm
- Weight: ± 118 kg
- Max. lifting capacity: 200 kg
- Electric motor: 6.000 N
- Power supply: 100 - 240 VAC, 50-60 Hz
- Current consumption: 1,5 A
- Insulation class: II
- Moisture resistance: IP 21
- Classification: I
- Conformity: IEC/EN 60601-1
- IEC/EN 60601-2
- CAN/CSA C22.2 No. 6011
- MDD 93/42/EEC

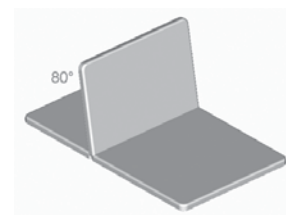
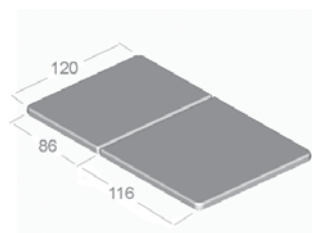

BOBATH ADVANCED

CODE	DESCRIPTION	CONTROL MECHANISM	CASTORS	FACE CUSHION
8891	Gymna Bobath Advanced	Electric Foot Switch	Castors	No face Hole



HILL-ROM® OB-GYN STRETCHER

With its fast and easy patient positioning, Hill-Rom's OB-GYN Stretcher (P8050) is ideal for use in both maternity and emergency

Features:

- 700lbs weight capacity
- Sliding litter enables quick and easy patient positioning
- Stowaway foot section eliminates heavy lifting and storage concerns
- Integrated foot supports save time by eliminating the need to search for stirrups and calf supports
- Integrated catch basin, combined with patient grip handles, offers convenience and saves time
- Next generation steering plus™ system for crisp cornering and control
- Dual-locking four-wheel brakes for a strong, stable platform
- Power washable
- Three year parts warranty and lifetime frame weld warranty



HILL-ROM® ELECTRIC STRETCHER

Combining the comfort of a hospital bed with the mobility of a stretcher

Features:

- 700lbs weight capacity
- Built-in scale shows kilograms and pounds simultaneously
- Low height for safer stretcher ingress and egress
- 5-inch air mattress (Prime Aire ARS® mattress) for patient comfort - the first non-powered air mattress for a stretcher
- Active hand brake - the world's first stretcher hand brake to help you negotiate ramps and corners without using your body weight and for safe and easy stops
- Integrated IV pole transport device helps to manoeuvre stretcher and a portable IV pole with ease
- Next generation Steering Plus™ system for crisp cornering and control
- Dual-locking, four-wheel brakes for a strong, stable platform
- Three year parts warranty and life-time frame weld warranty



HILL-ROM® PROCEDURAL STRETCHER

The ideal choice for emergency

Features:

- 700lbs weight capacity
- Built-in scale shows kilograms and pounds simultaneously
- Low height (20.7") for safer stretcher ingress and egress - best in class
- 5-inch air mattress (PrimeAire ARS® mattress) for patient comfort - the first non-powered air mattress for a stretcher
- BackSaver Fowler™ feature for easier articulation of the head section
- Auto Contour™ option helps prevent patients from slipping down the mattress
- Active hand brake - the world's first stretcher hand brake to help you negotiate ramps and corners without using your body weight and for safe and easy stops
- Integrated IV pole transport device helps to manoeuvre stretcher and a portable IV pole with ease
- Next generation Steering Plus™ system for crisp cornering and control
- Dual-locking, four-wheel brakes for a strong, stable platform
- Power washable
- Three year parts warranty and life-time frame weld warranty



HILL-ROM® TRAUMA STRETCHER

Ideal for use in trauma and emergency

Features:

- 700lbs weight capacity
- Built-in scale shows kilograms and pounds simultaneously
- Full-length lift platform accepts all standard-size x-ray cassettes and grids
- Upright chest x-ray cassette holder
- Active hand brake - the world's first stretcher hand brake to help you negotiate ramps and corners without using your body weight and for safe and easy stops
- Integrated IV pole transport device helps to manoeuvre stretcher and a portable IV pole with ease
- Next generation Steering Plus™ system for crisp cornering and control
- Dual-locking four-wheel brakes for a strong, stable platform
- Power washable
- Three year parts warranty and lifetime frame weld warranty



HILL-ROM® SURGICAL STRETCHER

Flexible surgical stretcher ideal for any surgical setting

Features:

- 700lbs weight capacity
- Low height for safer stretcher ingress and egress
- Articulating head section for maximum flexibility
- Surgical rail for easy attachment of gas, extenders, and hand tables
- Integrated IV pole transport device helps manoeuvre the stretcher and a portable IV with ease
- Next generation Steering Plus™ system for crisp cornering and control
- Dual-locking, four-wheel brakes for a strong, stable platform
- Power washable
- Three year parts warranty and lifetime frame weld warranty



SIDHIL INSPIRATION COT

The accepted industry standard for paediatric cots and the only one still produced in volume entirely in the UK. Designed expressly to meet a comprehensive range of paediatric requirements, the Inspiration Cot brings together a range of innovative functions with bright and attractive colourways, which combine to make the cot particularly attractive for the paediatric environment.

Features:

- Colourful and aesthetically pleasing design
- Designed for flexibility; variable height, electrically operated, two-way tilting mattress platform
- Removable head and foot ends allow 360° access when the side rails are down
- Unimpeded access with uniquely designed drop-down telescopic side rails
- Dual sided, linked, tracking and braking system for added safety
- Up to two removable transfusion poles can be fitted
- Includes specially designed visco elastic mattress for maximum comfort
- Lullaby dynamic pressure cradle also available
- Buffers on all four corners and a shelf for linen
- 9003 model features manual CPR and hinge system on head and foot ends to feed cables/leads and tubes into cot
- 3 year warranty (1st year parts & labour, 2nd and 3rd year parts only)
- Maximum user weight when not in tilt: 160kg (25st)
- Maximum user weight when in tilt: 50kg (8st)

CODE	DESCRIPTION
13351	Sidhil Inspiration Cot





OSCIMED CAST SAWS AND EXTRACTION UNITS

The Oscimed 2000 is a very low noise level cast saw with patented anti-noise technology. The Oscimed 2000 consists of a brushless, fanless 100W-24V motor.

It has been ergonomically designed with a modern shape for single handed use. The saw has an instant blade change ability with a patented non-slip lock nut.

Oscimed technology includes saw blades with a noise-suppressing central core.

This vacuum cleaner possesses four levels of filtration (including two filters to HEPA standards) and filters dust down to 3 microns. It has a tough, powerful construction with a support for the saw and vacuum hose. The unit comes complete with an electricity supply socket for the saw. Available in 1-speed version (1000W).

- Sound level: 62dB in speed 1
- Suction: 2200mm water gauge, 50 litres/sec
- Length of vacuum hose: 3 metres
- Capacity of stainless steel tank: 20 litres
- Weight: 12 kg



OSCIMED CAST SAW AND EXTRACTION VACUUM UNIT

CODE	DESCRIPTION
20101	Oscimed Cast Saw
20102	Oscimed Extraction Vacuum Unit
20102B	Oscimed Blade For Synthetic Blade 65mm
20102C	Oscimed Blade for POP 65mm
20102D	Oscimed Blade - Titanium 65mm
20102A	Oscimed Dust Bags 10/box
13413	Oscimed Cast Spreader





WELCH ALLYN®
DIAGNOSTICS



WELCH ALLYN® CONNEX® VITAL SIGNS MONITOR 6000 SERIES

The Connex VSM is an advanced, touch screen monitor featuring bright, vivid colours with minimal knobs or buttons for ease of cleaning - perfect for general care floors within the hospital and also for surgery centres and other ambulatory care offices. For hospitals, working with Connex VM software, clinicians can improve workflow by wirelessly sending patient vitals directly to the EMR from the bedside.

- SureBP® technology measures BP as cuff is inflating
- Supports adult, paediatric and neonatal
- Pulse rate and MAP included
- SureTemp Plus thermometry
- Masimo® or Nellcor® pulse oximetry
- Fast recharging lithium-ion battery
- Interval programmes for automatic readings

FOR HOSPITALS

- Get immediate access to accurate patient vitals
- Wireless capability allows data to be sent to the EMR anytime anywhere
- Profiles, controls, alarms, and configures to specific workflows
- Advanced patient ID verifies patient name
- Connects to all leading EHR systems to reduce documentation errors

Multiple models available.



Spot-check vitals

Monitoring

Triage

CABLE MANAGEMENT STAND

The Accessory Cable Management Stand, with its unique accessory storage and cable routing system, is ergonomically designed for ease of use. This helps keep everything neat and organized, so users can work efficiently and project confidence and professionalism when they interact with patients.



THE FOLLOWING RESPIRATORY MONITORY OPTIONS ARE AVAILABLE



1. ORIDIAN TECHNOLOGY



Surestream incorporates a unique sample technology for enhanced waveform integrity and accuracy that works with Welch Allyn CVSM:



2. MASIMO RESP TECHNOLOGY



Acoustic Respiration Rate (RRa™) is a breakthrough measurement that allows clinicians to noninvasively and continuously assess patients' breathing—facilitating earlier detection of respiratory compromise and patient distress.



3. EARLY SENSE TECHNOLOGY



Optional EarlySense® contact-free respiratory monitoring and motion sensing.

Falls Prevention, Pressure area Prevention and Respiratory Monitoring.





CONNEX® INTEGRATED WALL SYSTEM (CVSM MONITOR WITH THE DIAGNOSTIC SYSTEM)

The Connex Integrated Wall System is an advanced vitals management and physical assessment solution that has everything a busy department needs to quickly exam the patient and make decisions based on accurate, complete information.

- Fast 15-second NIBP and pulse rate
- SureTemp Plus and/or Braun ThermoScan® PRO 4000 ear thermometry
- Masimo® or Nellcor® pulse oximetry
- Adult, pediatric, and neonatal blood pressure modes
- NIBP interval monitoring mode, including customizable interval programs
- Programmable visual and audible alarms for BP, SpO2, temperature and pulse
- Integrated 3.5 V handles for physical assessment tools
- Can be electronically sent directly to the EMR/EHR system



WELCH ALLYN® SPOT VITAL SIGNS® LXI

- SureBP measures blood pressure in about 15 seconds as the cuff is inflating - resulting in time savings for you and improved comfort for your patients. Pulse rate and MAP included
- Braun ThermoScan® PRO 4000 ear thermometer
- Nellcor® or Masimo® pulse oximetry
- Ability to manually enter weight, height, respiration rate, and pain level calculates body mass index
- 50-reading memory allows retrieval of previous data for review or to download later
- Bigger, brighter LCD display provides greater visibility from farther distances



CODE	DESCRIPTION
445NEOE6	NIBP/Nellcor Pulse Oximetry and PRO 4000
445NTOE6	NIBP/Nellcor Pulse Oximetry and Suretemp
445MEOE6	NIBP/ Masimo Pulse Oximetry and Pro 4000
445MTOE6	NIBP/ Masimo Pulse Oximetry and Suretemp
STAND	
40470060	Mobile Stand for Spot LXI



WELCH ALLYN® SPOT VITAL SIGNS®

- Take vital signs in seconds with hospital-grade technology that spot checks vital signs easily, accurately and affordably
- Automated measurement of non-invasive blood pressure (NIBP), pulse rate, temperature and pulse oximetry in 30 seconds
- Lightweight and portable with a variety of mounting options
- All configurations include NIBP, Pulse Rate and mean arterial pressure (MAP)
- Optional—SureTemp® Thermometry, Nellcor® or Masimo® pulse oximetry



WELCH ALLYN® CONNEX® PROBP™ 3400

Puts consistent, accurate blood pressure readings at everyone's fingertips

- Small, handheld design makes device easy to carry and capture readings on rounds or in triage settings
- The option of choosing SureBP™ technology that enables fast, accurate 15-second blood pressure readings, improving patient comfort
- Obtains accurate readings and minimises error codes, even in the presence of many cases of motion or weak pulse
- Bluetooth® wireless and USB-wired technology enables connectivity to select EMR/HIS systems, improving documentation accuracy and efficiency

SureBP = SureBP® technology measures blood pressure in about 15 seconds as the cuff is inflating — resulting in time savings for you and improved comfort for your patients, pulse rate and MAP included.

Standard BP = Takes the BP as the cuff deflates as a traditional sphyg or monitor does.



CODE	DESCRIPTION
442NOBE6	NIBP/Nellcor Pulse Oximetry
442NTBE6	NIBP/Temperature/Nellcor Pulse Oximetry
442MOB-E6	NIBP/Massimo Pulse Oximetry
442MTB-E6	NIBP/Temperature/Massimo Pulse Oximetry
STAND	
40470060	Mobile Stand

CODE	DESCRIPTION
4034XFHT-6	W/A Connex® ProBP™ 3400 with SureBP™ - Handheld
4034XXHT-6	W/A Connex® ProBP 3400™ with Normal BP - Handheld
MOUNTING OPTIONS	
40460261	W/A Desk Mount for ProBP
40460161	W/A Wall Mount for ProBP
40460061	W/A Mobile stand for ProBP

NELLCOR



40DS100A
Adult Finger Probe



40DEC-8
Extension Cable

400XIPI Paediatric/Infant Oxiband



40D-YSPD
Paediatric Spot Check



40D-YS
Dura Y Sensor



40DYSE Ear Clip

CODE	DESCRIPTION (NELLCOR®)
40DEC-4	Nellcor® Extension Cable
40DS100A	Nellcor® Adult Finger Sensor
400XIPI	Nellcor® Paediatric/Infant Posy Wrap Oxiband Sensor
40D-YSPD	Nellcor® Paediatric Spot Check (used with 40DYS)
40D-YS	Nellcor® Dura Y Sensor
40DYSE	Nellcor® Ear Clip (used with 40D-YS)

MASIMO

ID00766



ID00768



ID00767



CODE	DESCRIPTION (MASIMO)
ID00766	Adult Sensor LNCS - DCI
ID00768	Paediatric Sensor LNCS - DCP
ID00767	4 ft Extension Cable

WELCH ALLYN®
CUFF GUIDE

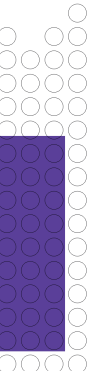

Need a BP Cuff?

Already using FlexiPort™?

NO

How many tubes ?

1 Tube



*NB - Substitute 'X' in the above codes with the number indicating the blood pressure cuff size required. Refer to "Welch Alllyn FlexiPort™ Blood Pressure Cuff Size and Range Guide".

2 Tube



YES

REUSABLE (Cuff only. No tubing or connector. Each)

- REUSE-06 Small Infant
- REUSE-07 Infant
- REUSE-08 Small Child
- REUSE-09 Child
- REUSE-10 Small Adult
- REUSE-11 Adult
- REUSE-11L Adult Long
- REUSE-12 Large Adult
- REUSE-12L Large Adult Long
- REUSE-13 Thigh



DISPOSABLE (Cuff only. No tubing or connector. Box of 20)

- SOFT-06 Small Infant
- SOFT-07 Infant
- SOFT-08 Small Child
- SOFT-09 Child
- SOFT-10 Small Adult
- SOFT-11 Adult
- SOFT-11L Adult Long
- SOFT-12 Large Adult
- SOFT-12L Large Adult Long
- SOFT-13 Thigh



SINGLE PATIENT USE CUFFS (Cuff only. No tubing or connector. Box of 50, 2 Box / Case)

- ECOCUFF-09 Child
- ECOCUFF-10 Small Adult
- ECOCUFF-11 Adult
- ECOCUFF-12 Large Adult



Welch Alllyn Australia

Unit 5, 38-46 South Street, Rydalmere NSW 2116

Phone: 02 9638 3000 | Fax: 02 9638 3500 | www.welchallyn.com.au

© 2013 Welch Alllyn | WAAA-MC1300 Rev A

WelchAlllyn™

Advancing Frontline Care™

Welch Allyn FlexiPort™ Blood Pressure Cuff Size and Range Guide

Reusable and Disposable

- 06 = Small Infant, 7-10cm
- 07 = Infant, 9-13cm
- 08 = Small Child, 12-16cm
- 09 = Child, 15-21cm
- 10 = Small Adult, 20-26cm
- 11 = Adult, 25-34cm
- 11L = Adult Long, 25-34cm
- 12 = Large Adult, 32-43cm
- 12L = Large Adult Long, 32-43cm
- 13 = Thigh, 40-55cm

EcoCuff™ Single Patient Use Cuffs

- 09 = Child, 15-21cm
- 10 = Small Adult, 20-28cm
- 11 = Adult, 27-38cm
- 12 = Large Adult, 33-45cm

Neonatal Soft Disposable Blood Pressure Cuffs

ALSO AVAILABLE

One-Tube with Luer Slip Connector

- 5082-101-1 Neonate, Size 1, 1-Tube (10 per box)
- 5082-102-1 Neonate, Size 2, 1-Tube (10 per box)
- 5082-103-1 Neonate, Size 3, 1-Tube (10 per box)
- 5082-104-1 Neonate, Size 4, 1-Tube (10 per box)
- 5082-105-1 Neonate, Size 5, 1-Tube (10 per box)
- 5082-241-9 Neonate, Multi-Pack, 1-Tube (5 per box)

Two-Tube with Luer Slip Connector

- 5082-101-2 Neonate, Size 1, 2-Tube (10 per box)
- 5082-102-2 Neonate, Size 2, 2-Tube (10 per box)
- 5082-103-2 Neonate, Size 3, 2-Tube (10 per box)
- 5082-104-2 Neonate, Size 4, 2-Tube (10 per box)
- 5082-105-2 Neonate, Size 5, 2-Tube (10 per box)
- 5082-241-10 Neonate, Multi-Pack, 2-Tube (5 per box)

*Neonatal cuffs do not have FlexiPort™ technology

FlexiPort™ Information

PORT-1 One-Tube FlexiPort™ fitting without tubes or connectors.



PORT-2 Two-Tube FlexiPort™ fitting without tubes or connectors.



5082-159 Wash cap that tethers to FlexiPort™ on cuffs. This allows users to close off the FlexiPort during washing.





ARE YOU TAKING AN ACCURATE BLOOD PRESSURE?

Step 1 - Choose the right equipment:

A blood pressure measurement instrument that has been calibrated for measurement accuracy annually. Welch Allyn has revolutionised Manual Blood Pressure design by creating gear free technology that has fewer moving parts – stays accurate longer. Enables blood pressure gauges to withstand drops of up to 1.5 meters and still maintain calibration. Most of the Welch Allyn Automated BP products use SureBP technology that enables fast, accurate 15-second blood pressure readings, improving patient comfort. Obtains accurate readings and minimises error codes, even in the presence of many cases of motion or weak pulse.

Step 2 - Prepare the patient:

Make sure the patient is relaxed by allowing 5 minutes to relax before the first reading. The patient should sit upright with their upper arm positioned so it is level with their heart and feet flat on the floor. Remove excess clothing that might interfere with the bp cuff or constrict blood flow in the arm. Be sure you and the patient refrain from talking during the reading.

Step 3 - Choose the proper BP cuff size:

Welch Allyn have a large range of cuffs.



The size is correct when the artery indicator is within the size range marked on the cuff

The Welch Allyn BP Cuffs have a 3 year warranty and are all Latex Free. They will fit all of your blood pressure devices. The Flexiport cuffs allow you to use one cuff in virtually every room and on virtually every device you have.

Benefits:

- Minimize the risk of cross-contamination and control infections - the cuffs have an anti-microbial coating and are easy to clean
- Eliminate confusion caused by multiple tube and connector configurations
- FlexiPort cuffs meet the AAMI and AHA specifications
- Long cuffs are designed to allow practitioners to take blood pressure readings on patients who have short and stocky arms. Size 11L and 12L
- Tubing can rotate 360 degrees to stop pressure on patients arm

YOU CAN CHANGE SIZES AT THE CUFF

Means not worrying about connectors missing



BE AWARE!!!

THE FOLLOWING ACTIVITIES AFFECT A BLOOD PRESSURE READING:

ACTIVITY	SYSTOLIC (MMHG)	
Cuff Too Small	10 TO 40	↑
Cuff Over Clothing	10 TO 40	↑ OR ↓
Back/Feet Unsupported	5 TO 15	↑
Legs Crossed	5 TO 8	↑
Not Resting 3 To 5 Minutes	10 TO 20	↑
Patient Talking	10 TO 15	↑
Labored Breathing	5 TO 8	↑
Full Bladder	10 TO 15	↑
Pain	10 TO 30	↑
Arm Below Heart	1.8 /INCH	↑
Level	4.6 /CM	↑
Arm Above Heart	1.8 /INCH	↓
Level	4.6 /CM	↓

RANGE OF SIZES AVAILABLE

CUFF	RANGE
SM. INFANT (6)	7-10 CM
INFANT (7)	9-13 CM
SM. CHILD (8)	12-16 CM
CHILD (9)	15-21 CM
SM. ADULT (10)	20-26 CM
ADULT (11)	25-34 CM
ADULT LONG (11L)	25-34 CM
LARGE ADULT (12)	32-43 CM
LG. ADULT LONG (12L)	32-43 CM
THIGH (13)	40-55 CM



DISPOSABLE BP CUFFS

Welch Allyn FlexiPort disposable blood pressure cuffs are the top choice for infection-control conscious hospitals and clinics around the world. That's because we offer virtually every type of cuff an institution may need, along with the ability to simplify inventory like no other cuff provider with our patented FlexiPort.

CUFF	RANGE	CODE	DISPOSABLE CUFFS (ALSO AVAILABLE IN OTHER SIZES)
Child (9)	15-21 cm	40-SOFT-09	
Adult (11)	25-34 cm	40-SOFT-11	
Large Adult (12)	32-43 cm	40-SOFT-12	



ECO CUFF

FlexiPort® EcoCuff™ Single Patient Use Blood Pressure Cuff

One true solution to help facilities reduce cost, cross-contamination, and environmental impact.

New technology that provides an optimized single patient use solution which maximizes value while minimizing cross-contamination related to BP cuffs. Single-point connection facilitates a simple standardization solution. Uniquely designed for and marked as single patient use. Designed to last an entire patient stay – Tested to 100 on/offs and BP cycles.

- Eco Cuff is available in a 'raw' format only (no tubes or connectors) – Reduces waste and cost.
- Eco Cuff are not wrapped individually – Reduces waste
- Eco Cuff is 100% Polypropylene – Capable of being Recycled (#5), reducing environmental impact
- Eco Cuff features a unique slot fitting system – Helps prevent miscuffing
- Eco Cuff meets all the latest clinical guidelines for proper fit from AAMI and AHA

Sizes

- ECO-09 EcoCuff, Child, 15-21 cm
- ECO-10 EcoCuff, Small Adult, 20-28 cm
- ECO-11 EcoCuff, Adult, 27-38 cm
- ECO-12 EcoCuff, Large Adult, 33-45 cm

TYCOS® 767-SERIES WALL AND MOBILE ANEROIDS

Great looks and clinical-grade accuracy make the 767-Series one of the best Tycos aneroids ever.

- Laser-engraved dial face provides unmatched accuracy
- Recessed dial face and high contrast red pointer increase visibility and reduce parallax errors
- Lifetime calibration warranty
- New 5-leg stand provides improved stability and manoeuvrability
- Simple colour changes give the aneroid a new look
- Latex and mercury free



TYCOS® 767-SERIES WALL AND MOBILE ANEROIDS

CODE	DESCRIPTION
40767001	Wall Aneroid with Adult Cuff
40767010	Mobile Aneroid with Adult Cuff - 5 legged stand
40767016	Desk Aneroid with Adult Cuff

Cuff Options for (Wall and Mobile Sphygmomanometers)

2 TUBE - CUFFS INCLUDING CONNECTOR + BULB + VALVE

CODE	DESCRIPTION
40-10-2BV	W/A Flexiport Cuff with Bulb and Valve - Small Adult - 2 Tube
40-11-2BV	W/A Flexiport Cuff with Bulb and Valve - Adult - 2 Tube
40-12-2BV	W/A Flexiport Cuff with Bulb and Valve - Large Adult - 2 Tube

TWO TUBE - CUFFS INCLUDING CONNECTOR

CODE	DESCRIPTION
40-06-2TP	Flexiport Cuff - Small Infant
40-07-2TP	Flexiport Cuff - Infant
40-08-2TP	Flexiport Cuff - Small Child

40-09-2TP	Flexiport Cuff - Child
40-10 -2TP	Flexiport Cuff - Small Adult
40-11-2TP	Flexiport Cuff - Adult
40-11L-2TP	Flexiport Cuff - Adult - Long
40-12-2TP	Flexiport Cuff - Large Adult
40-12L-2TP	Flexiport Cuff - Large Adult - Long
40-13-2TP	Flexiport Cuff - Thigh

CUFF ONLY

CODE	DESCRIPTION
40Reuse06	W/A Flexiport Cuff - Small Infant
40Reuse07	W/A Flexiport Cuff - Infant
40Reuse08	W/A Flexiport Cuff - Small Child
40Reuse09	W/A Flexiport Cuff - Child
40Reuse10	W/A Flexiport Cuff - Small Adult
40Reuse11	W/A Flexiport Cuff - Adult
40Reuse11L	W/A Flexiport Cuff - Adult - Extra Long
40Reuse12	W/A Flexiport Cuff - Large Adult
40Reuse12L	W/A Flexiport Cuff - Large Adult - Extra Long



40509827

TYCOS® DS66 HAND ANEROID

- Certified accuracy to ±3 mmHg
- Trigger deflation valve for smooth, one-finger operation
- Latex-free for safety
- Durable one-piece cuff
- Polyester zip case
- Laser-engraved dial for accuracy
- Shock resistant for accuracy and lower cost over time
- 15-year calibration warranty



40509830

TYCOS® DS66 HAND ANEROID

CODE	DESCRIPTION
40509827	Hand Aneroid with Adult Durable One-Piece Cuff
40509828	Hand Aneroid with Large Adult Durable One-Piece Cuff
40509830	Hand Aneroid with Large Adult, Adult, Small Adult and Child Durable One-Piece Cuffs

CUFFS FOR USE WITH DS66

One Tube - Bladderless Cuffs Including Connectors

CODE	DESCRIPTION
40-06-1TP	Flexiport Cuff - Small Infant
40-07-1TP	Flexiport Cuff - Infant
40-08-1TP	Flexiport Cuff - Small Child
40-09-1TP	Flexiport Cuff - Child
40-10-1TP	Flexiport Cuff - Small Adult
40-11-1TP	Flexiport Cuff - Adult
40-11L-1TP	Flexiport Cuff - Adult - Long
40-12-1TP	Flexiport Cuff - Large Adult
40-12L-1TP	Flexiport Cuff - Large Adult - Long
40-13-1TP	Flexiport Cuff - Thigh

Cuff Only

Code	Description
40Reuse06	W/A Flexiport Cuff - Small Infant
40Reuse07	W/A Flexiport Cuff - Infant
40Reuse08	W/A Flexiport Cuff - Small Child
40Reuse09	W/A Flexiport Cuff - Child
40Reuse10	W/A Flexiport Cuff - Small Adult
40Reuse11	W/A Flexiport Cuff - Adult
40Reuse11L	W/A Flexiport Cuff - Adult - Extra Long
40Reuse12	W/A Flexiport Cuff - Large Adult
40Reuse12L	W/A Flexiport Cuff - Large Adult - Extra Long



WELCH ALLYN® DURASHOCK™ MODEL DS55 HAND ANEROID

The DS55 provides a traditional thumbscrew-style air release valve and identification labels that can be customised. The DS55 is available in four colour schemes - blue, yellow, red and black.

- Laser-engraved dial for accuracy
- Shock resistant for accuracy and lower cost over time
- 10-year calibration warranty
- Premium aesthetics

WELCH ALLYN® DURASHOCK™ MODEL DS45 - INTEGRATED ANEROID

- The first gear-free, shock-resistant aneroid sphygmomanometer with integrated cuff
- Meets AAMI shock-resistant standard for enhanced durability
- Laser-engraved dial face for accuracy
- Gauge rotates 360° for easy viewing and snaps directly into cuff for quick cuff change
- Lightweight and latex-free for safety
- Durable one-piece cuff
- 10-year warranty

WELCH ALLYN® DURASHOCK™ MODEL DS55 HAND ANEROID

CODE	DESCRIPTION
5041	W/A DS55 Sphyg - Blue
5042	W/A DS55 Sphyg - Chrome
5043	W/A DS55 Sphyg - Red
5044	W/A DS55 Sphyg - Yellow

ADDITIONAL CUFF OPTIONS

CODE	DESCRIPTION
40Reuse06	W/A Flexiport Cuff - Small Infant
40Reuse07	W/A Flexiport Cuff - Infant
40Reuse08	W/A Flexiport Cuff - Small Child
40Reuse09	W/A Flexiport Cuff - Child
40Reuse10	W/A Flexiport Cuff - Small Adult
40Reuse11	W/A Flexiport Cuff - Adult
40Reuse11L	W/A Flexiport Cuff - Adult - Extra Long
40Reuse12	W/A Flexiport Cuff - Large Adult
40Reuse12L	W/A Flexiport Cuff - Large Adult - Extra Long

WELCH ALLYN® DURASHOCK™ MODEL DS45 - INTEGRATED ANEROID

CODE	DESCRIPTION
40DS4511	DS45 Sphygmomanometer Complete

OTHER CUFF SIZES FOR DS45

40Reuse06	W/A Flexiport Cuff Small Infant
40Reuse07	W/A Flexiport Cuff Infant -
40Reuse08	W/A Flexiport Cuff small Child -
40Reuse09	W/A Flexiport Cuff Child -
40Reuse10	W/A Flexiport Cuff Small Adult
40Reuse11	W/A Flexiport Cuff - Adult -
40Reuse12	W/A Flexiport Cuff Large Adult
40Reuse12L	W/A Flexiport Cuff Large Adult - Xtra Long

CUFFS BELOW ARE USED WITH OLD DS45 (ONE WITH WHITE CUFF)

CODE	DESCRIPTION
40DS4509	BP Cuff with bulb - Child
40DS4510	BP Cuff with bulb - Small Adult
40DS451F	BP Cuff with bulb - Adult
40DS4512	BP Cuff with bulb - Large Adult

WELCH ALLYN® DURASHOCK™ MODEL DS44 - INTEGRATED ANEROID

- The first gear-free, shock-resistant aneroid sphygmomanometer with integrated cuff
- Meets AAMI shock-resistant standard for enhanced durability
- Laser-engraved dial face for accuracy
- Gauge rotates 360° for easy viewing and snaps directly into cuff for quick cuff change
- Lightweight and latex-free for safety
- Durable one-piece cuff
- 10-year warranty



WELCH ALLYN® DURASHOCK™ MODEL DS44 - INTEGRATED ANEROID

CODE	DESCRIPTION
40DS4411	DS44 Sphygmomanometer Complete
40DS411V	DS44 Sphygmomanometer Complete - with coloured Bumpers





OTHER CUFF SIZES FOR DS44

40Reuse06	W/A Flexiport Cuff Small Infant
40Reuse07	W/A Flexiport Cuff Infant
40Reuse08	W/A Flexiport Cuff small Child
40Reuse09	W/A Flexiport Cuff Child
40Reuse10	W/A Flexiport Cuff Small Adult
40Reuse11	W/A Flexiport Cuff - Adult
40Reuse12	W/A Flexiport Cuff Large Adult
40Reuse12L	W/A Flexiport Cuff Large Adult - Xtra Long

CUFFS BELOW USED WITH OLDER DS44

CODE	DESCRIPTION
40DS4409	BP Cuff with bulb - Child
40DS4410	BP Cuff with bulb - Small Adult
40DS441F	BP Cuff with bulb - Adult
40DS4412	BP Cuff with bulb - Large Adult

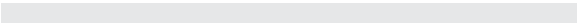
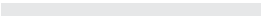
WELCH ALLYN® FLEXIPORT PARTS

CODE	DESCRIPTION	PART
40PORT1	W/A Sphyg Flexiport Port 1 Tube	
40PORT2	W/A Sphyg Flexiport Port 2 Tube	
5082-189	W/A Sphyg Flexiport Tube 13"	
5082-188	W/A Sphyg Flexiport Tube 8"	
5082-159	W/A Sphyg Flexiport Cap	

Triple-leaf binaural spring encased in polyurethane allows size adjustment while preventing breakage

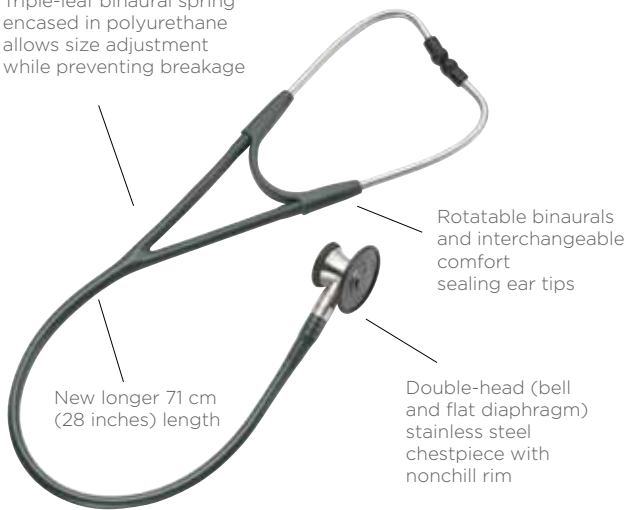

Rotatable binaurals and interchangeable comfort sealing ear tips

New longer 71 cm (28 inches) length

Double-head (bell and flat diaphragm) stainless steel chestpiece with nonchill rim

HARVEY™ ELITE® STETHOSCOPE

The Harvey Elite offers updated styling with the superior comfort and auscultation capabilities cardiologists have come to rely on. Its stainless steel head transmits sounds crisply and clearly. The Harvey Elite comes with a 10-year warranty and a pediatric chestpiece.



5079-232 Accessory Kit

(Includes one pediatric chest piece, one flat diaphragm, one corrugated diaphragm, one pair soft eartips, one pair hard eartips)



What is the advantage of a two-tube stethoscope?

Two-tube stethoscopes, such as the Harvey DLX and Elite, provide an individual sound channel to each ear. This allows you to hear the subtle characteristics of heart sounds and murmurs more distinctly. The heavier tubing also filters out the distracting noise typical of a busy environment. Welch Allyn Harvey stethoscopes have both a bell and diaphragm to easily isolate high-(diaphragm) and low-frequency (bell) sounds. Some stethoscopes have only a diaphragm. Harvey stethoscopes have adjustable binaurals for a customized, comfortable fit.



PROFESSIONAL DIAGNOSIS STETHOSCOPE

Excellent acoustic clarity and durability

Welch Allyn General Diagnosis stethoscopes provide excellent sound quality, durability, and comfort for the practicing professional. Their acoustics allow for accurate auscultation of cardiac, pulmonary, and vascular sounds.

Excellent for general auscultation and blood pressure

- Double-head design
- Adult and Pediatric versions available
- Stainless steel chestpiece and binaurals
- Rotatable binaurals and interchangeable comfort sealing eartips
- Latex free
- 5-year warranty



GENERAL EXAM STETHOSCOPE

- General-use stethoscope
- Lightweight chestpieces with nonchill rims
- Adjustable chrome-plated binaurals
- Latex-free, flexible, single-channel tubing
- Two-year warranty



INTEGRATED WALL SYSTEMS

- Help reduce facility cost with an energy efficient product
- Standardize your facility with a sturdy, predrilled mounting board that mounts easily to any wall
- Choose either PanOptic™ Ophthalmoscope or the Coaxial Ophthalmoscope
- Choose either MacroView™ Otoscope or Diagnostic Otoscope
- Help improve workflow with contoured handles that automatically turn on/off
- Configure to meet your needs with the choice of the Wall Aneroid, ProBP™ Digital Blood Pressure Device, Spot Vital Signs® Device or Spot Vital Signs® LXi Device
- Optional KleenSpec® Disposable Dispenser
- Optional SureTemp® Plus 690 Electronic Thermometer



767 WALL TRANSFORMER WITHOUT CLOCK (HEADS NOT INCLUDED)

CODE	DESCRIPTION
4076716	W/A Wall Transformer with 2 Handles (you must add an Otoscope and Ophthalmoscope to your order)

OPTIONAL EXTRAS

4052400	Ear Speculum Holder/ Dispenser
4400101	Mobile Stand (to mount the Wall Charger only)

OPHTHALMOSCOPE AND OTOSCOPE HEADS FOR WALL CHARGERS

OPHTHALMOSCOPE HEADS

CODE	DESCRIPTION
4011720	W/A 3.5v Ophthalmoscope Head
OR 4011820	W/A Pan Optic Head

OTOSCOPE HEADS

4020000	W/A 3.5v Diagnostic Otoscope Head
4025020	W/A 3.5v Diagnostic Otoscope Head - without Throat Illuminator - (use with locking collars)
4023820	W/A MacroView Otoscope Head

DIAGNOSTIC SETS

Part Number	Wall Board	GS 777 Wall Transformer	Coaxial Ophthalmoscope	PanOptic Ophthalmoscope	Macroview Otolaryngoscope use with locking collars	Speculum Dispenser	Wall Aneroid	Suretemp Plus Thermometer	Connex ProBP	Spot
77791-2MPX	<input checked="" type="checkbox"/>	<input checked="" type="checkbox"/>	4011720	4011820	4023810	4052400-PF	40767001	<input checked="" type="checkbox"/>		
77792-M	<input checked="" type="checkbox"/>	<input checked="" type="checkbox"/>	<input checked="" type="checkbox"/>		<input checked="" type="checkbox"/>	<input checked="" type="checkbox"/>	<input checked="" type="checkbox"/>			
77792-MN0BP	<input checked="" type="checkbox"/>	<input checked="" type="checkbox"/>	<input checked="" type="checkbox"/>		<input checked="" type="checkbox"/>	<input checked="" type="checkbox"/>				
GS 777 Integrated Wall System with ProBP										
77791-MXPROBP	<input checked="" type="checkbox"/>	<input checked="" type="checkbox"/>	<input checked="" type="checkbox"/>		<input checked="" type="checkbox"/>	<input checked="" type="checkbox"/>		<input checked="" type="checkbox"/>	<input checked="" type="checkbox"/>	
77791-M2MPXPROBP	<input checked="" type="checkbox"/>	<input checked="" type="checkbox"/>	<input checked="" type="checkbox"/>		<input checked="" type="checkbox"/>	<input checked="" type="checkbox"/>		<input checked="" type="checkbox"/>	<input checked="" type="checkbox"/>	
GS 777 Integrated Wall System with Spot VSM										
77794-MSPOT	<input checked="" type="checkbox"/>	<input checked="" type="checkbox"/>	<input checked="" type="checkbox"/>		<input checked="" type="checkbox"/>	<input checked="" type="checkbox"/>				<input checked="" type="checkbox"/> Spot Ordered Separately
77794-2MPSPOT	<input checked="" type="checkbox"/>	<input checked="" type="checkbox"/>		<input checked="" type="checkbox"/>	<input checked="" type="checkbox"/>	<input checked="" type="checkbox"/>				<input checked="" type="checkbox"/> Spot Ordered Separately

GREEN SERIES DESK SYSTEMS

Welch Allyn Green Series Diagnostic Desk Systems Now everything you need for Patient exams in one convenient Desk System.

YOU CAN BUY THE DESK MOUNT ON IT'S OWN AND ADD YOUR OWN DIAGNOSTIC PRODUCTS OR BUY IT WITH SPHYGMOMANOMETER, THERMOSCAN, HANDLES AND DIAGNOSTIC HEADS.



add your own handles/heads etc



407753576

Green Series™ Diagnostic Desk System

- Desk charger only. No Handles, Diagnostic Heads, Thermometer or Sphygmomanometer.



40775346

Green Series™ Diagnostic Desk System

- 767 Desk Aneroid with Adult Blood Pressure Cuff
- One 3.5 V Li-Ion Handle
- 3.5 V MacroView Otoscope
- ThermoScan® Thermometer with a box of 20 Probe Covers



407753586

Green Series™ Diagnostic Desk System

- 767 Desk Aneroid with Adult Blood Pressure Cuff
- Two 3.5 V Li-Ion Handles
- 3.5 V MacroView™ Otoscope
- PanOptic Ophthalmoscope
- ThermoScan® Thermometer with a box of 20 Probe Covers



77535-66 Green Series™ Diagnostic Desk System

- 767 Desk Aneroid with Adult Blood Pressure Cuff
- Two 3.5 V Li-Ion Handles
- 3.5 V MacroView Otoscope
- Coaxial Ophthalmoscope
- ThermoScan® Thermometer with a box of 20 Probe Covers

DIAGNOSTIC SETS





4071638



4071736

- Desk Charger with x 2 Silver Handles
- Desk Charger with x 2 Lithium-Ion Handles

UNIVERSAL DESK CHARGER SETS (heads not included)

- Keep your diagnostic instruments powered up and ready to go with our most popular handles and instruments in one easy-to-order set
- Coloured LEDs signal power is “on” and instruments are charging
- Advanced circuitry ensures constant, safe charging and optimum, long-lasting lamp life

Add: The Ophthalmoscope and Otoscope Heads to Desk Charger and Wall Charger

UNIVERSAL DESK CHARGER SETS

CODE	DESCRIPTION
4071736	Desk Charger with 2 x Lithium-Ion Handles
4071638	Desk Charger with 2 x Silver Handles

OPHTHALMOSCOPE AND OTOSCOPE HEADS FOR DESK CHARGERS

OPHTHALMOSCOPE HEADS

CODE	DESCRIPTION
4011720	W/A 3.5v Ophthalmoscope Head
OR 4011820	W/A Pan Optic Head

OTOSCOPE HEADS

4020000	W/A 3.5v Diagnostic Otoscope Head
4025020	W/A 3.5v Diagnostic Otoscope Head - without Throat Illuminator - (use with locking collars)
4023820	W/A MacroView™ Otoscope Head



4097206C



4097206L



409720MC



409720ML



409720MP

3.5V DIAGNOSTIC SETS IN CASES

Keep your diagnostic instruments together and easily portable, with our most popular handle and instruments in one easy-to-order set.

- Choice of the PanOptic Ophthalmoscope or 3.5v Coaxial Ophthalmoscope
- Diagnostic Otoscope with Halogen HPX™ lamp provides 30% more light output
- Convertible Ni-Cad handle uses rechargeable battery (included) or C-cell batteries
- Comes complete with a zippered, hard case for secure storage and easy portability
- Available in multiple configurations

LED SETS ALSO AVAILABLE FOR CODE 409720MP (409720MP-LED)

3.5V DIAGNOSTIC SETS

CODE	DESCRIPTION
4097206C	3.5v Diagnostic Set including: Diagnostic Otoscope Head with Throat Illuminator, Coaxial Ophthalmoscope Head, Silver Nickel Cadmium Handle, 3.5v Charger, Zip-up Case
4097206L	3.5v Diagnostic Set including: Diagnostic Otoscope Head with Throat Illuminator, Coaxial Ophthalmoscope Head, Black Lithium-Ion Handle, Lithium-Ion Charging Pod, 3.5v Charger, Zip-up Case
409720MC	3.5v Diagnostic Set including: MacroView™ Otoscope Head with Throat Illuminator, Coaxial Ophthalmoscope Head, Silver Nickel Cadmium Handle, 3.5v Charger, Zip-up Case
409720ML	3.5v Diagnostic Set including: MacroView™ Otoscope Head with Throat Illuminator, Coaxial Ophthalmoscope Head, Black Lithium-Ion Handle, Lithium-Ion Charging Pod, 3.5v Charger, Zip-up Case
409720MP	3.5 Diagnostic Set including: MacroView™ Otoscope Head with Throat Illuminator, Pan Optic Ophthalmoscope Head, Black Lithium-Ion Handle, Lithium-Ion Charging Pod, 3.5v Charger, Zip-up Case



3.5V PANOPTIC™ OPHTHALMOSCOPE HEAD

The revolutionary PanOptic™ provides easier entry into the eye, together with a dramatically wider field of view to more easily evaluate head trauma, papilledema and retinal haemorrhage.

- 5x larger view of the fundus vs standard scopes in an undilated eye
- 25° field of view vs the standard 5° field of view
- Greater working distance improves comfort for both practitioner and patient
- Detect corneal abrasions with cobalt blue filter and corneal viewing lens
- Compatible with all existing Welch Allyn 3.5v power sources
- Free diagnostic wall chart available

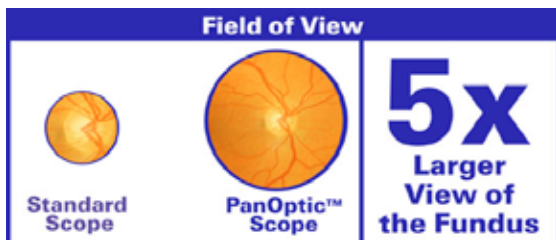

TURN YOUR PANOPTIC INTO A CAMERA

The new Welch Allyn iExaminer turns the PanOptic Ophthalmoscope into a mobile digital imaging device allowing you to view and take pictures of the eye like you've never done before. The adapter aligns the optical access of the PanOptic Ophthalmoscope to the visual axis of the iPhone 4 or 4S camera to capture high resolution (5/ 8 megapixel*) pictures of the fundus and retinal nerve.



3.5V STANDARD COAXIAL OPHTHALMOSCOPE HEAD

- Halogen HPX™ lamp provides 30% whiter, brighter light for true tissue colour and long-lasting performance
- Detect corneal abrasions and foreign bodies with cobalt blue filter
- Coaxial optical system produces shadow-free spot viewing
- Polarising filter virtually eliminates corneal reflection
- Sealed optics keep out dust and dirt

3.5V PANOPTIC™ HEAD (HEAD ONLY)

CODE	DESCRIPTION
4011820	W/A PanOptic™ Head (head only)

3.5V STANDARD COAXIAL HEAD (HEAD ONLY)

CODE	DESCRIPTION
4011720	W/A 3.5v Ophthalmoscope Head



3.5V DIAGNOSTIC OTOSCOPE HEAD

- Halogen HPX Lamp provides 30% more light output for true tissue colour and long-lasting performance
- Fibre optics project cool light to the distal tip with no reflections or obstructions, for clear viewing of the tympanic membrane
- Sealed system allows for pneumatic otoscopy and accurate diagnosis of otitis media



3.5V MACROVIEW™ OTOSCOPE

The MacroView™ Otoscope offers a significant advance in hand-held otoscopy, providing the practitioner with an improved view for enhanced decision making.

- Enables nearly a full view of the tympanic membrane with 30% more magnification
- Focusable eyepiece
- Tip grip for more secure speculum attachment
- Halogen HPX™ lamp provides 30% more light output for true tissue colour and long-lasting performance
- Fibre optics project cool light to the distal tip with no reflections or obstructions, for clear viewing of the tympanic membrane
- Sealed system allows for pneumatic otoscopy and accurate diagnosis of otitis media
- Simply detach the head for high-intensity

3.5V DIAGNOSTIC OTOSCOPE

CODE	DESCRIPTION
4020000	W/A 3.5v Diagnostic Otoscope (head only)
4025020	W/A 3.5v Diagnostic Otoscope Head without Throat Illuminator - (use with locking collars)

3.5V MACROVIEW™ OTOSCOPES

CODE	DESCRIPTION
4023820	W/A MacroView™ Otoscope
4023810	W/A MacroView™ Otoscope Head without Throat Illuminator - (use with locking collars)



3.5V DIGITAL MACROVIEW™ OTOSCOPE

Offering you clear, live and still images of the ear canal and tympanic membrane, the Digital MacroView™ Otoscope is a valuable tool in support of the treatment and management of your patient's ears.

Easy to learn and use, the Digital MacroView™ is a plug and play system requiring no additional purchase of software.

3.5V DIGITAL MACROVIEW™ OTOSCOPE

CODE	DESCRIPTION
4023920	3.5v Digital MacroView™ Otoscope (head and cable only)

OTOSCOPE ACCESSORIES



4023804



4052700



4024330/4024320



DISPOSABLE EAR SPECULUM

CODE	DESCRIPTION
4052432U	Disposable Ear Speculum - 2.75mm - (Paediatric) - 34 Per Tube
4052434U	Disposable Ear Speculum - 4.25mm - (Adult) - 34 Per Tube

TO CREATE A SEAL (PUT OVER THE SPECULUM)

4024330	SofSeal Single Use Sealing Tip, Medium
4024320	SofSeal Single Use Sealing Tip, Small

INSUFFLATION BULBS

CODE	DESCRIPTION
4021504	W/A Insufflation Bulb to use with 4020000 Otoscope
4023804	W/A Insufflation Bulb to use with 4023820 MacroView™ Otoscope

NEW SLOTTED SPECULA

4052700	Disposable Instrumentation Tip for MacroView™
---------	---



POCKETSCOPE™ OTOSCOPE WITH THROAT ILLUMINATOR

Small, convenient, and easy to use with bright, white halogen light and a built-in throat illuminator.

- Halogen light for true tissue colour and consistent, long-lasting illumination
- Simply detach the otoscope head to use the throat illuminator or all-purpose penlight
- Fiber optics provide cool light with no reflections or obstructions
- Wide-angle viewing lens allows for instrumentation under magnification
- Sealed system for pneumatic otoscopy

POCKETSCOPE™ OPHTHALMOSCOPE

Lightweight, compact diagnostic instruments deliver high performance in a slightly smaller package.

- Halogen light for true tissue colour and consistent, long-lasting illumination
- 12 aperture/filter combinations for greater versatility: micro, small, and large spot sizes, cobalt blue filter for corneal exams, fixation target, and slit aperture, plus red-free filter and unfiltered halogen
- 48 focusing lenses for better resolution



2.5V POCKETSCOPE™ SET

POCKETSCOPE™

CODE	DESCRIPTION
4022820	W/A Pocket Otoscope 2.5v
4022821	W/A Pocket Otoscope w/case
4012820	W/A Pocket Ophthalmoscope 2.5v
4092821	W/A Pocket Scope Set (Soft case)



Lithium-Ion Handle, Charging Pod and Charger

INDIVIDUAL HANDLES

NB: If you want to purchase an individual Otoscope or Ophthalmoscope then add one of the below handles to one of the Otoscope or Ophthalmoscope heads on previous pages.



Nickel Cadmium Handle

Charger

NICKEL CADMIUM HANDLE

CODE	DESCRIPTION
4071020C + 4071036	Silver Nickel Cadmium Handle Plus Charger

LITHION-ION HANDLE

4071910 + 4071940 + 4071036	Black Lithium-Ion Handle + Lithium-Ion Charging Pod + Charger
-----------------------------------	---



**PRO6000
COMING
SOON**

PRO4000 EAR THERMOMETER

The new Braun ThermoScan® Pro4000 Ear Thermometer offers you the speed and accuracy you need for all types of patients. The exclusive ExacTemp technology provides an active user feedback system to ensure proper positioning and improved accuracy.

- Improved accuracy and repeatability through a preheated probe tip and sensor
- Probe cover detection system ensures precise infrared heat transfer for accurate temperatures
- Automatic probe cover eject button for quick and easy disposal of used probe covers
- Easy-to-read, backlit LCD displays temperatures in fahrenheit or celsius
- Three year limited warranty

PRO400 EAR THERMOMETER

CODE	DESCRIPTION
4004000	W/A ThermoScan® Braun Pro 4000
4005075	W/A ThermoScan® Probe Covers - 200/pkt



SURETEMP® PLUS 692

- Ergonomic design - comfortable to hold, easy to use, and very durable
- Interchangeable, removable probe wells reduce the risk of cross-contamination
- Large LCD display with location identification capability
- Includes a 60-second pulse timer for counting pulses and respirations
- Mechanical or electronic security options to help prevent theft
- Takes approximately 5,000 readings on 3 AA batteries
- Wall mount standard with the SureTemp® Plus 692 model



SURETEMP® PLUS 690

- Interchangeable, removable probe wells reduce the risk of cross-contamination
- Large LCD displays temperatures in Fahrenheit or Celsius
- Last temperature recall
- Convenient storage for 25 probe covers
- Takes approximately 6,000 readings on 3 AA batteries



	SURETEMP PLUS 690	SURETEMP PLUS 692
Probe Cover Storage	X	X
F/C Conversion	X	X
Last Temperature Recall	X	X
Monitor Mode	X	X
Detachable Probe	X	X
Oral/Pediatric Axillary (< 18 years), Adult Axillary, Rectal Modes on each unit	X	X
Color Coded Removable Probe Well	X	X
Wall Holder Included (standard)		X
Pulse Timer		X
Backlight		X
Optional Security (mechanical)	X	X
Security (electronic)		X
On-Screen Labeling for Instrument ID		X
Warranty on Probe	1 year	1 year
Warranty on Probe Well	90 days	90 days
Warranty on Thermometer Unit	2 years	3 years



SOLID STATE PROCEDURE LED HEADLIGHT

Targeted, well-defined illumination without the heat of traditional headlights.

- Weighs just 170 grams - extremely comfortable to wear for both simple and complex procedures
- Supplies bright, white, shadow-free light for true tissue colour
- Optional rechargeable battery pack makes this a completely portable, compact unit that allows the user freedom of movement



4046076R

SOLID STATE PORTABLE LED HEADLIGHT

Provides illumination precisely where it is needed, with cool, bright light that ensures comfort for both clinician and patient.

- Weighs just 113 grams - one of the most comfortable and lightweight headlights available
- Fits inside a shirt pocket and allows the user complete freedom of movement
- Supplies bright, white, shadow-free light for true tissue colour



4075266



4075200



4005232

SOLID STATE PROCEDURE LED HEADLIGHT	
CODE	DESCRIPTION
4049026	Procedure LED Headlight with Leather Headband - Attaches to Mains
4075266	Optional Battery Pack and Charger

SOLID STATE PORTABLE HEADLIGHT AND ACCESSORIES	
CODE	DESCRIPTION
4046076	Portable LED Headlight with Towelling Headband - Battery Operated + Charger
4046076R	Portable LED Headlight with Rigid Headband - battery operated + Charger
4049642	Replacement Towelling Bands
4005232	Zip-up Storage Case



4020506H

LUMIVIEW™ PORTABLE BINOCULAR MICROSCOPE

Unique 3D optics for viewing into small cavities. Adapts optical properties of binocular microscope to converge user's vision into a magnified, stereoscopic 3-dimensional view.

- Directs cool halogen light to the spot for clear 3D image and accurate depth perception
- Simple to use, easy to carry and very affordable



4020506S



EPISCOPE®/DERMATOSCOPE

3.5 V EpiScope® skin surface microscope

Helps distinguish pigmented skin lesions such as basal cell carcinoma vs malignant melanoma by providing the ability to magnify, illuminate and measure.

- Provides 10 times magnification and illumination for crisp, clear viewing
- Reticle contact plate facilitates measurement and tracking of lesion growth
- Fits any 3.5v Welch Allyn® handle
- Halogen illumination for true tissue colour

LUMIVIEW™ PORTABLE BINOCULAR MICROSCOPE	
CODE	DESCRIPTION
4020506S	LumiView™ with Portable Power Pack + Charger - Spectacle Mounted
4020506H	LumiView™ with Portable Power Pack + Charger - Headband Mounted

3.5V EPISCOPE® SKIN SURFACE MICROSCOPE	
CODE	DESCRIPTION
4047300	W/A EpiScope™ Head Only



LED VAGINAL SPECULA ILLUMINATION SYSTEM

Superior visualisation - advanced LED light source provides better visualisation of the exam area by supplying brighter, whiter light, right where it is needed.

- Cordless and rechargeable - no cord to get in the way or break during procedures, continuous on time of 80 minutes, recharge time of six hours, lithium-ion battery technology
- Automatic on/off - no more hassle with turning the unit on and off. When the new KleenSpec® Illumination System is inserted into the 590 Vaginal Speculum it is automatically



VAGINAL SPECULA OLDER ILLUMINATION SYSTEM

Conduct exams more completely and confidently with a vaginal specula that transmits brighter, whiter halogen lighting to the speculum tip and directly onto the cervix.

- Moulded-in light carrier projects halogen lighting to the speculum tip and directly onto the cervix for clearer viewing and diagnosis
- Illumination system includes 6v halogen light handle, on/off switch, and transformer
- One-handed angulation and elevation provides multiple settings with positive-locking positions for easy operation

NEW LED VAGINAL SPECULA ILLUMINATION SYSTEM

CODE	DESCRIPTION
4079916	W/A Vaginal LED System

VAGINAL SPECULA ILLUMINATION SYSTEM

CODE	DESCRIPTION
4078800	Vaginal Light Handle Only
4073416	Vaginal Transformer Only
4078816	Vaginal Light Handle + Transformer



KLEENSPEC® DISPOSABLE 590 SERIES VAGINAL SPECULA

- Smooth, moulded acrylic for maximum patient comfort
- Disposable for safety, economy and convenience

KLEENSPEC® DISPOSABLE VAGINAL SPECULA

CODE	DESCRIPTION
4059004	Disposable Vaginal Speculum - Large
4059001	Disposable Vaginal Speculum - Medium
4059000	Disposable Vaginal Speculum - Small
405900xs	Disposable Vaginal Speculum - xtra Small



Vaginal Illuminator and 586 Series Specula

VAGINAL ILLUMINATOR AND SPECULAS (USED TOGETHER)

CODE	DESCRIPTION
4058600	Disposable Vaginal Speculum - Small (needs 4078600 as well)
4058601	Disposable Vaginal Speculum - Medium (needs 4078600 as well)
4078600	Vaginal illuminator (can be autoclaved 50 times) - 6/box



FIBRE OPTIC ANOSCOPE/SIGMOIDOSCOPE SET

For convenience, safety, and optimal performance.

- Brilliant halogen light for true tissue colour
- Fibre optic light transmission gives unobstructed vision with 360° of cool, white light
- 45° bevel at distal end to facilitate instrumentation for Anoscope

A complete system that allows you to achieve the perfect balance between patient comfort and optimal clinical performance.

4030210



4030215

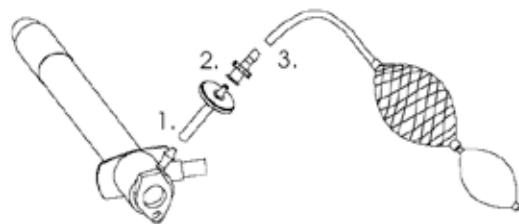

FIBRE OPTIC - ANOSCOPE/SIGMOIDOSCOPE SET

CODE	DESCRIPTION
4053110	Disposable Anoscope
4053130	Disposable Sigmoidoscope
4036019	Rectal - Fiber Optic Light Source
4073210	Rectal Light Handle
4073338	Rectal Transformer
4030210	Disposable Filters - 10/box (must be used with 40503130)
4030215	Connector used with Filters - 10/box

WHITER, BRIGHTER AND GREENER LIGHTS

LEDs, which never require replacement, provide a whiter, brighter light than ever before and consume less energy. So now you can see true tissue colour rendition during an exam or procedure while also reducing your cost of ownership.



Mobile



Wall



Mobile



Ceiling

- Touchless Full
- Touchless Semi
- Touchless On/Off

GS EXAM LIGHT IV

The GS Exam Light IV features:

- A single LED that provides whiter, brighter light than halogen, so you see truer tissue colour rendition during an exam
- Less energy consumption for reduced cost of ownership
- No bulb replacement for cost savings
- A compact, unobtrusive head ensuring pinpoint accuracy
- Minimal heat dissipation
- Touchless on/off
- 5 year limited warranty

GS900 PROCEDURE LIGHT

Six 5,500° K LEDs that provide a whiter, brighter light than halogen.

- Less energy consumption for reduced cost of ownership
- No bulb replacement for cost savings
- Combines outstanding durability, extraordinary manoeuvrability, unparalleled spot quality and multiple mounting options
- Dimming feature
- Minimal heat dissipation and high colour temperature
- 5 year limited warranty



Wall

GS EXAM LIGHT IV

CODE	DESCRIPTION
4048816	Exam Light - includes Wall Mount
4048950	Mobile Stand for Exam Light

GS900 PROCEDURE LIGHT

CODE	DESCRIPTION
4044906	W/A Light GS900 with Stand
4044900-W	W/A Light GS900 - Wall Mounted
4044900-C	W/A Light GS900 - Ceiling Mount



GS600 MINOR PROCEDURE LIGHT

- Three LEDs that provide a whiter, brighter light than halogen
- Less energy consumption for reduced cost of ownership
- No bulb replacement for cost savings
- Wider head, designed specifically for demanding viewing conditions
- Uniform spot and superior brightness for minor procedures and exams in any healthcare environment
- Minimal heat dissipation
- Touchless controls with dimming features
- 5-year limited warranty

GS300 GENERAL EXAM LIGHT

- A single LED that provides whiter, brighter light than halogen
- Less energy consumption for reduced cost of ownership
- No bulb replacement for cost savings
- A perfect combination of intense light output and cool operation all delivered in a compact design
- An affordable price and rugged performance
- Minimal heat dissipation
- Touchless on/off
- 5-year limited warranty



149cm High (Tall)



179cm High (Short)

Optional Wall Mount:

4044215- W/A GS600 and GS300 arm extension - 315mm from the wall



Tall and Short Stand Options:



GS600 MINOR PROCEDURE LIGHT

CODE	DESCRIPTION
4044616	W/A Light GS 600-Wall
MOBILE LIGHT OPTIONS - SHORT OR TALL	
4044606	W/A Light GS 600 - Mobile- 149cm High
4044616 + 4048960	W/A Light GS 600-Wall + Tall stand - 179cm high

GS300 GENERAL EXAM LIGHT

CODE	DESCRIPTION
4044416	W/A Light GS 300 - wall mount
MOBILE OPTIONS - SHORT OR TALL STAND	
4044456	W/A Light GS 300- Mobile - 149cm tall
4044416+ 4048960	W/A Light GS 300 - wall mount + Tall stand - 179cm tall

WELCH ALLYN'S FLEXIBLE FAMILY OF CARDIOPULMONARY PRODUCTS YOU CAN ATTACH TO YOUR PATIENT NOTES

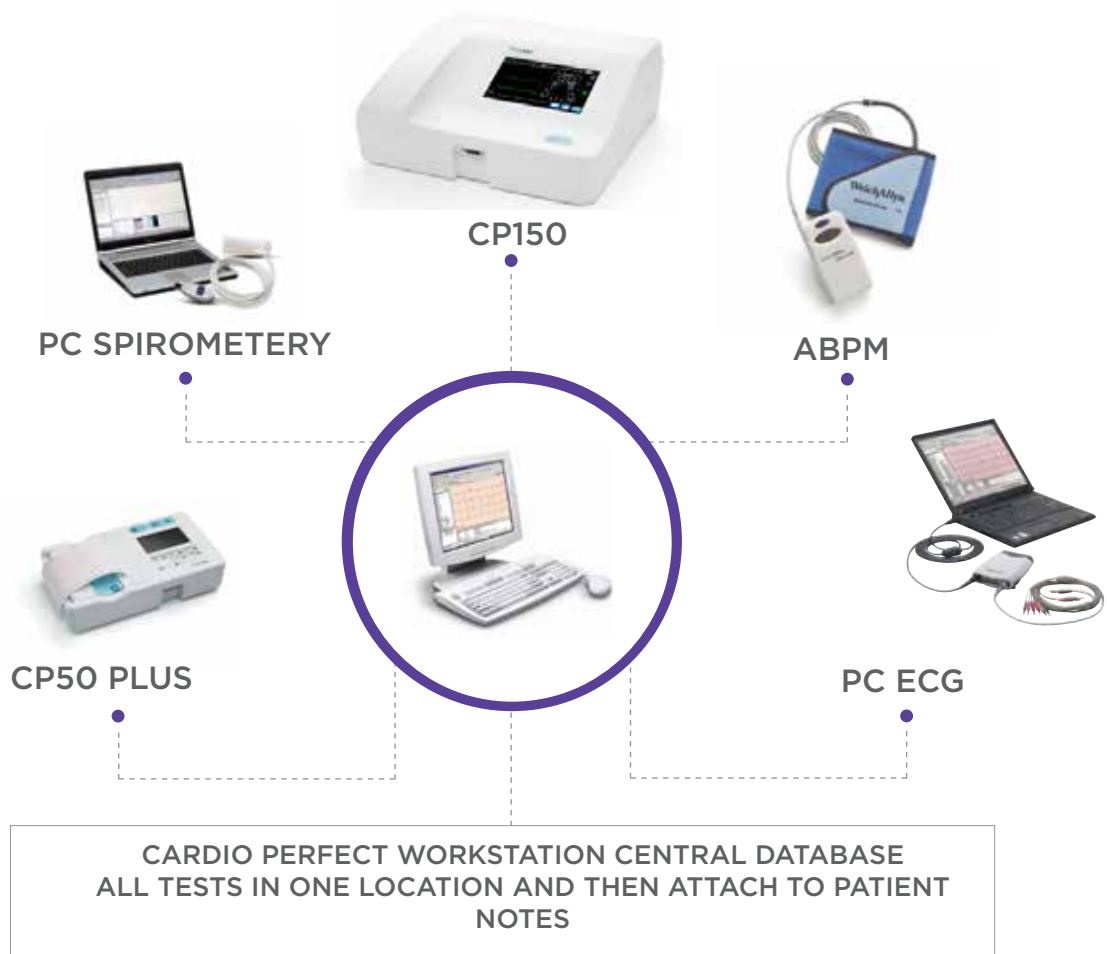

CP50 PLUS

- Simple, 12 lead multichannel ECG, interpretive, colour touch screen display and 4" thermal printer also external printing capability

CP150

- The Welch Allyn CP 150™ Electrocardiograph (ECG) offers simplicity with speed using a unique, 7" touch-screen display and keyboard – helping to improve accuracy. To meet the needs of fast-paced environments, take quick ECG readings with the touch of a button

PC SPIROMETRY

- Fast, reliable pre-/postbronchodilator FVC, SVC, and MVV testing with automatic interpretation and reversibility analysis
- Instantly verify quality and variability of test performance and compare previous tests using the trending tool

ABPM

- Accurate 24-hour ABPM ambulatory blood pressure monitoring with simple, one-button operation
- Oscilometric technology allows for easy patient hook-up
- Lightweight compact and quiet for improved patient compliance
- Dynamic inflation automatically limits maximum cuff pressure for patient comfort
- 100% latex-free cuffs reduce risk of allergic reactions
- New sleeve cuffs are machine washable due to removable bladder

PC ECG

12 lead resting ECG system including:

- Cardio Perfect Workstation software, digital ECG patient cable with USB connection, software for resting ECG



CP50™

Get the power of a fully-featured ECG in a compact, affordable, easy-to-use package with the new Welch Allyn® CP50™ electrocardiograph. With simple one-button operation the CP50™ makes performing ECG tests easy for trained caregivers of all skill levels.

And with advanced features like a full-colour, touch-screen display, high-resolution thermal printer, and a full range of EMR connectivity options, the CP50™ gives you the options your practice needs at a price that fits your budget.

CP50™ standard features

- Reliable colour touchscreen display
- On-screen instructions that guide you through a test
- Programmable report formats
- High-resolution thermal printer
- Optional mobile stand and carrying case

CP50™ Plus with connectivity features

All features of the CP50™, plus:

- Connects to the CardioPerfect™ Workstation for paperless efficiency with full suite of Welch Allyn® cardiopulmonary devices
- Flexible connectivity options: EHR, HIS, email, web, telemedicine
- External printer integration
- Programmable patient entry fields



CP150™

The Welch Allyn CP 150™ Electrocardiograph (ECG) offers simplicity with speed using a unique, 7" touch-screen display and keyboard — helping to improve accuracy. To meet the needs of fast-paced environments take quick ECG readings with the touch of a button.

- 7" Color, touch screen display for fast and easy entry of accurate patient information
- Instant-on feature powers the device up quickly and lets you take an ECG at a moment's notice
- Advanced filters for optimal ECG trace quality ensure accurate readings
- Three (3) lead ECG preview
- Battery operation lets you easily transport your device to the patient
- Store up to 100 test results on the device or transfer to a USB memory stick
- A4 Printout



CP50™

CODE	DESCRIPTION
40CP50	W/A ECG CP50™ Basic
40CP50PLUS	W/A ECG CP50™ Plus

CP150™

CODE	DESCRIPTION
40CP150	W/A Interpretive ECG with A4 printout

Replacement Leads for CP200



Alligator Clip



ECG Tabs



Spirometer Sensors



Nose Clip



Paper



Pressure Tubing



Calibration Syringe

ACCESSORIES

CODE	DESCRIPTION
------	-------------

ECG ACCESSORIES

4058581	W/A ECG Alligator Clip Set
4045008	W/A ECG Electrodes - Tab - 100/pkt
4094018	W/A ECG Paper CP100™, CP200™ and CP150™
406021	W/A ECG Paper CP50™

ECG TROLLEY

401393	CP100™/CP200™ Office Cart, without Cable Arm/ Shelf
401161	Cable Arm and Shelf Option, CP 100™/200™ Cart

ACCESSORIES

CODE	DESCRIPTION
------	-------------

SPIROMETER ACCESSORIES

40703419	W/A Spiro Disp Sensors - 100/pkt
4073418	W/A Spiro Disp Sensors - 25/pkt
40100680	W/A Spiro Nose Clips - 25/pkt
40703415	W/A Spiro Pressure Tubing

CONNECTIVITY AND STORAGE



Welch Allyn® CardioPerfect™ Workstation Software



Welch Allyn® CP150™ Transfer Information Via USB Stick



Welch Allyn® CP50+™ Transfer Information Via USB Stick

OPTIONAL ACCESSORY - CONNECTIVITY AND STORAGE FOR COMPUTER

CODE	DESCRIPTION
------	-------------

406814	CP50/CP150 Connectivity Kit to the CardioPerfect™ Workstation. Kit includes: CardioPerfect™ Workstation Software (404093), Connex CSK Software CD (406003), Ethernet Cable, USB Cable
--------	---

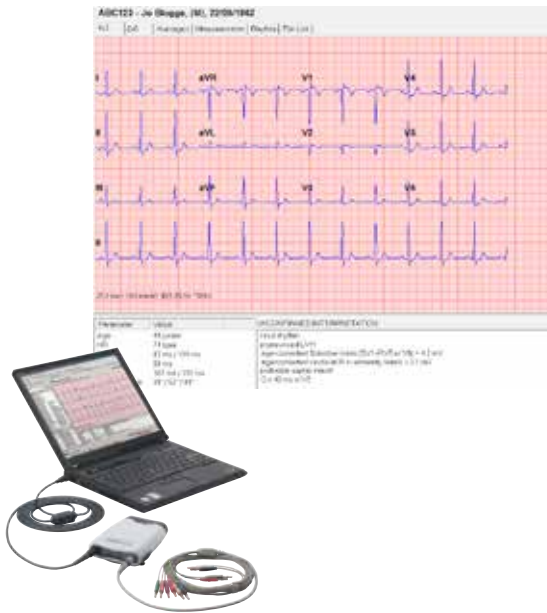

PC-BASED RESTING ECG FULLY INTERPRETIVE

Turns any PC into a full-featured electrocardiograph. Intuitive Windows® operation makes it easy for your staff to learn and use, while the power and features of a PC-based system save money and increase utilisation of existing equipment.

- Large screen display saves time and eliminates repeat ECGs
- ECG measurements speed physician review and interpretation
- Programmable report formats that print on plain paper using inkjet or laser printer
- On-screen ECG report editor lets you change or add a diagnosis
- Serial comparison lets you compare previous ECGs to highlight changes
- Upgradable - leverage your investment by adding spirometry and/or ABPM modules to complete your cardiopulmonary suite



PC-BASED SPIROPERFECT™ SPIROMETER

See and compare accurate results from pulmonary function tests in seconds. Clearly evaluate pulmonary obstruction or restriction, increase success rates for patients who are undergoing smoking cessation, show progress, and help paediatric patients comply with test procedures.

- Fast, reliable pre-/postbronchodilator FVC, SVC and MVV testing with automatic interpretation and reversibility analysis
- Instantly verify quality and variability of test performance and compare previous tests using the trending tool
- Motivate children with incentive graphic
- Reduce risk of cross contamination with single-use disposable transducers
- Easily monitor, review, store and print on your computer with Welch Allyn® CardioPerfect™ workstation software
- Interface with EMR or patient management systems for onsite or offsite review of key data

Minimum computer requirements

Hardware

- P4 or Higher with 1 GB or higher of RAM
- Monitor Resolution 1024x768 true color, 1280x1024 recommended
- Hard Disk with at least 20 GB with 5GB of free space
- 2 USB Ports

Software

- XP SP2 or later, Vista Business SP1 or later, Windows 7 Home Premium, Professional, or Ultimate, Windows 8 or windows 8 Pro

NB: Both 32- and 64-bit operating systems are supported

PC-BASED RESTING ECG

CODE	DESCRIPTION
40ECGI	W/A PC-Based Resting ECG, Interpretive Software - 12 Lead

PC-BASED SPIROPERFECT™ SPIROMETER

CODE	DESCRIPTION
40SPIRO-S	W/A SpiroPerfect™ Software and Hardware + Calibration Syringe



PC ABPM 6100 - (24 HOUR BP)

Accurate 24-hour ABPM ambulatory blood pressure monitoring with simple, one-button operation and powerful Windows®-based reporting software module, part of the CardioPerfect Workstation software suite

- Oscilometric technology allows for easy patient hook-up
- Lightweight, compact and quiet for improved patient compliance
- Dynamic inflation automatically limits maximum cuff pressure for patient comfort
- 100% latex-free cuffs reduce risk of allergic reactions
- Part of the Welch Allyn CardioPerfect™ Workstation software suite which provides versatile data storage and transfer of patient data to many leading EMRs
- New sleeve cuffs are machine-washable due to removable bladder

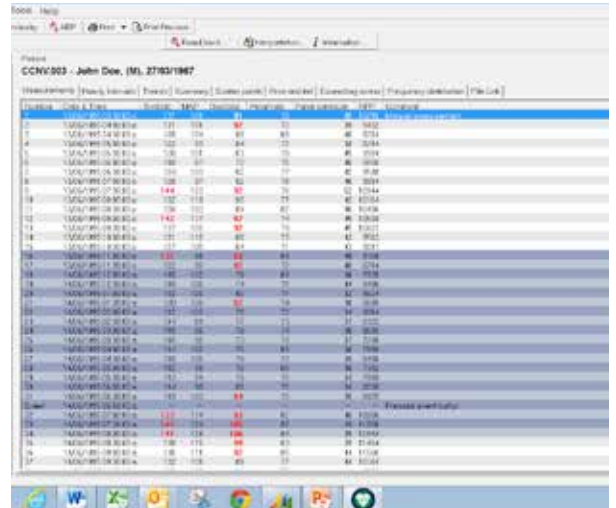

MINIMUM COMPUTER REQUIREMENTS FOR ECG, SPIRO AND ABPM

Hardware

- P4 or Higher with 1 GB or higher of RAM
- Monitor Resolution 1024x768 true color, 1280x1024 recommended
- Hard Disk with at least 20 GB with 5GB of free space
- 2 USB Ports

Software

- XP SP2 or later, Vista Business SP1 or later, Windows 7 Home Premium, Professional, or Ultimate, Windows8 or windows 8 Pro

NB: Both 32- and 64-bit operating systems are supported

CUFF SIZES - SINGLE USE PATIENT CUFFS CAN ALSO BE USED.

40101340	W/A PC-ABPM Small Adult Cuff - (18-27 cm)
40101341	W/A PC-ABPM Adult Cuff - (25-34 cm)
40101342	W/A PC-ABPM Adult Plus Cuff - (33-40 cm)
40101343	W/A PC-ABPM Large Adult Cuff - (39-46 cm)



FIBRE OPTIC LARYNGOSCOPE BLADES

Removable light pipes make these an affordable choice in fibre optic laryngoscope blades.

- Single-piece stainless steel construction ensures blade integrity
- Damaged light pathways can be repaired at a fraction of the cost of replacement blades

FIBRE OPTIC LARYNGOSCOPE BLADES

CODE	DESCRIPTION
E MAC CURVED BLADES	
4069211	1-E Mac - Child
4069212	2-E Mac - Adolescent
4069213	3-E Mac - Adult - Female
4069214	4-E Mac - Adult - Male

FIBRE OPTIC LARYNGOSCOPE BLADES AND HANDLES

CODE	DESCRIPTION
MILLER STRAIGHT BLADE (BEST FOR CHILDREN AND BABIES)	
4068060	0-Miller - Baby
4068061	1-Miller - Child
FIBRE OPTIC HANDLE	
4060813	W/A Fibre Optic Handle

LED UPGRADES

New patented technology with the familiarity of halogen and the performance benefits of LEDs. Four lamp upgrade kits cover a broad range of physical assessment instruments you use every day. Lamp bases are date-stamped for easy warranty verification. Kits include a lamp removal tool for easier replacement.

Long life

- Tested to 30X Halogen lamps
- Guaranteed 7 years

High performance

- Consistent colour output through dimming cycle
- Patented circuitry and colour rendering for specific clinical applications

Energy efficient

- 3x the on-time with Welch Allyn® rechargeable handles
- Lower operating temperature intended for greater patient/clinician comfort

30X Longer Life

- Tested to 30X halogen lamps
- Guaranteed 7 years

Halogen LED

Energy Efficient

- 3X the on-time vs. halogen with Welch Allyn 3.5 V rechargeable handles
- Lower operating temperature intended for greater patient/clinician comfort

Halogen LED

CODE	BULB AND PRODUCT	
4003100LED		
4004900LED		
4006500LED		
4003800LED		

LAMP AND BATTERY GUIDE

CODE		DESCRIPTION
4072200		71670 NiCad Handle Desk Charger 71020 Nickel Cadmium Handle
4072300		71020C Nickel Cadmium Handle
4071960		71910 Lithium-Ion Handle
4072250		LumiView™ Battery
4003100		Various Otoscopes and ENT Heads 25020 27000 20000 27050 21700 28100 20200 41100 20202 26030 73500 Rectal Adaptor (3.5V)
4003800U		11810 and 11820 Pan Optic
4004900		11720 Coaxial Ophthalmoscope
4006500U		23810 and 23820 MacroView™
4007800U		73210 Rectal 6v Light Handle 78000 Vaginal Light Handle
4008800U		78800 Vaginal Light Handle (4.6v)
4009500		49525 MFI Headlight



MICROTYMP® 3 - PORTABLE TYMPANOMETRIC INSTRUMENT

One of the fastest, easiest and most complete portable tympanometric instruments. Provides objective information for the diagnosis of otitis media

- Features 1,000 Hz quick-interpretation mode for testing infants under the age of 6 months
- Test in seconds—ideal for young or uncooperative patients
- Convenient cards and sleeve attach to charging base for easy documentation of 1,000 Hz results
- Foreground and background contrast LCD screen for easy viewing
- Three optional forms of information available for 226 Hz—tympanogram, numerical and interpretive data—making it flexible for your needs
- Compare middle ear function measurements side-by-side with easy-to-use graphs (226 Hz only)
- Tests print automatically or on-demand and can produce multiple copies for parent consultation or referral (for 226 Hz only—printing not available for 1,000 Hz)



EARTIPS FOR MICROTYMP 1 & 2



EARTIPS FOR MICROTYMP 3

CODE	DESCRIPTION
4093656	W/A Microtymper 3 with Printer includes Handle Charger/printer and tips
ACCESSORIES	
EARTIPS FOR MICROTYMP I & II	
4023621	W/A Microtymper Tip Small White
4023622	W/A Microtymper Tip Med Black
4023623	W/A Microtymper Tip Large Grey
4023624	W/A Microtymper Tip Xtra Large Blue
4023630	W/A Microtymper Tip Set 4Sizes
EARTIPS FOR MICROTYMP 3	
4024621	W/A Microtymper 3 Tips-xtra small - Black
4024622	W/A Microtymper 3 Tip - small - Beige
4024623	W/A Microtymper 3 Tips - Medium - Blue
4024624	W/A Microtymper 3 Tips - Large - Green
4024625	W/A Microtymper 3 Tips Xtra Large - White
4024620	W/A Microtymper 3 Tip-Set
PAPER	
4056100	W/A Microtymper II & 3 Printer Paper
4053600	W/A Microtymper I Printer Paper



HUNTLEIGH
CTG MONITORS



HUNTLEIGH CTG MONITORS

Sonicaid fetal monitors

The Huntleigh Sonicaid™ range of fetal monitors delivers innovative world-class obstetric solutions for midwives and obstetricians. Our extensive range allows monitoring throughout pregnancy in all environments.

Our success in fetal monitoring is born from more than 40 years' experience and whilst recognised as a major supplier of CTGs worldwide, we are continuously investing in new and improved solutions to meet the changing demands of our customers.

The range is complemented by our software systems which include maternity information, labour management and central review and archiving to satisfy all your hospital requirements.

**FOR MORE INFORMATION CONTACT:
USL MEDICAL CUSTOMER SERVICES ON 0800 658 814**



HUNTLEIGH SONICAID BD4000XS

Entry level monitoring

The BD4000xs series fetal monitors provide solutions for all areas of fetal monitoring. Using state of the art digital signal processing technology with enhanced FHR performance. The range includes antenatal and intrapartum models with a range of options and interface capabilities. This provides the most cost effective and flexible solution for all your fetal monitoring needs. Its compact size and styling belie its ruggedness and robust design, using the same materials, construction and design expertise as our world-renowned handheld dopplers.

Features:

- Twins capability as standard
- Unique no compromise full size twin FHR scale printing
- User adjustable, tachycardia, bradycardia, loss of contact and cross-channel rate verification alerts
- Hospital Information System and Vital Signs Monitor interface
- User-customisable trace annotation facility
- Automatic fetal movement detection
- Intuitive user interface and controls simplifying training
- Maternally sensed fetal movement marker
- FECG and IUP upgrade options



HUNTLEIGH SONICAID TEAM SERIES

Advanced fetal monitoring with CTG analysis

The Sonicaid Team range is designed for simplicity in fetal monitoring. Developed in collaboration with leading obstetric specialists, the small, easy to use and lightweight unit can be transported effortlessly - within hospitals, to clinics, doctors' offices or even to the home.

Features:

- Twin fetal heart rate scales provide the clearest differentiation between two heart rates and avoids the difficulty of interpreting offset or overlapping traces
- Obstetric management interface as standard
- Scrolling display of fetal heart rate and uterine activity traces
- Six hours of trace storage
- Records can be annotated at the touch of a button
- Maternally sensed and automatic (Actogram) fetal movement detection
- Tachycardia, bradycardia, signal loss and cross-channel rate verification alarms
- Twins (TeamCare Duo) and Intrapartum (Team IP) variants
- Care Antepartum CTG analysis provides an objective, numerical and consistent assessment of the CTG. Clinicians can rely on a large database of collective experience to support their own visual assessment
- Trend provides clear periodic changes over time in the FHR. For use during the first stage of labour, clinicians are quickly highlighted to changes in the variation, basal heart rate and deceleration size



HUNTLEIGH SONICAID FM800 ENCORE SERIES

High performance acute fetal/maternal intrapartum monitoring

The Sonicaid FM800 Encore is a high performance fetal and maternal monitor, using today's most advanced technology to produce the most accurate acquisition of data for clinician decision support. Whether you need standard fetal monitoring or equipment for specialist, high-risk care, the Sonicaid FM800 Encore series gives you accuracy and clarity in every situation.

In the fast-paced environment of the labour ward, you need equipment that's easy to use and data that is quick to read. The Sonicaid FM800 Encore gives you comprehensive fetal/maternal monitoring and analysis in one technologically advanced yet simple to use monitor.

- Using the very latest in ultrasound technology, the Sonicaid FM800 Encore gives increased performance. The wider, deeper, uniquely designed ultrasound beam shape makes it easy to locate and maintain contact with the fetal heart in mothers of all sizes
- Superbly accurate fetal ECG that works in the most demanding of environments - perfect for the busy labour room
- User defined alarm settings are held in memory for each new recording
- Unique Intelligent Fetal Analysis (IFA), providing fetal data analysis to support professional assessments
- Care Antepartum CTG analysis provides an objective, numerical and consistent assessment of the CTG. Clinicians can rely on a large database of collective experience to support their own visual assessment
- Trend intrapartum analysis provides clear periodic changes over time in the FHR. For use during the



DOPPLERS & ACCESSORIES



D900 VASCULAR DOPPLER

*Non-directional doppler

The Dopplex® D900 is a low cost audio only, non-directional doppler, principally used for ABPI measurements by community nurses and doctors in their role of leg ulcer management.

- Clear audio sounds of blood flow or fetal heart
- Enhanced battery management
- Compatible with the complete range of vascular probes. When used with EZ8 probe it is excellent for the infrequent user in locating brachial and pedal arteries
- Large carry bag and headphones included

*Probe sold separately



MD2 VASCULAR DOPPLER

*Bi-directional doppler

The Dopplex® MD2 is one of the most advanced pocket dopplers on the market. It provides the ability for high level vascular assessment, and is ideal for the detection of peripheral arterial disease. When used with the high sensitivity vascular probes it provides quality bi-directional blood flow information. It can be linked to the Dopplex® Reporter software package for high quality waveform reports or the Dopplex® Printa for single waveform recordings.

- Connects with all high sensitivity probes (2, 3, 4, 5, 8, 10 MHz)
- Provides bi-directional blood flow information and documentation
- Integral battery management
- Enhanced audio output
- Large carry bag will hold sphyg and cuffs

*Probe sold separately

D900 VASCULAR DOPPLER	
CODE	DESCRIPTION
10044	Huntleigh Vascular Doppler D900

MD2 VASCULAR DOPPLER	
CODE	DESCRIPTION
10215	Huntleigh Vascular Doppler MD2



SD2 VASCULAR DOPPLER

*Bi-directional doppler

The Dopplex® SD2 provides bi-directional vascular information to the vascular professional including the display of flow direction. It is ideal for clinical specialists wishing to conduct advanced doppler studies.

- Compatible with all high sensitivity vascular probes (audio only with OP2 and OP3)
- Ideal for ABPI assessment
- Provides bi-directional blood flow information
- Enhanced stereo audio output
- Large carry bag
- Stereo headphones included

*Probe sold separately



DFK

Diabetic Foot Assessment Kit

The Diabetic Foot Assessment Kit provides the professional vascular or diabetes specialist with a system to help in the assessment of neuropathy, ankle brachial pressure index (ABPI) and toe brachial pressure index (TBPI).

- Bi-directional doppler (MD2) and probe (VP8HS)
- Neuropen (includes 10g monofilament)
- Trigger operated sphyg with a range of latex free cuffs (arm/ankle, large and small toe)
- Educational DVD
- Hard carry case
- Set of guides (ABPI/TBPI)
- Headphones
- Box of Neuropen tips

SD2 VASCULAR DOPPLER

CODE	DESCRIPTION
ID00817	Huntleigh Vascular Doppler SD2

DFK

CODE	DESCRIPTION
10088	Huntleigh Diabetic Foot Assessment Kit

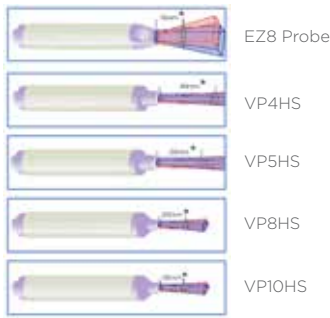

IOP - Single Probe Image

HUNTLEIGH DOPPLER ACCESSORIES

High sensitivity doppler probes

Based on over 20 years' experience in this field, the latest generation of the world renowned Dopplex® hand-held doppler range offers even greater performance, quality and value for money.

The range now has significantly enhanced features including:

- Improved probe design with 50% greater efficiency to give increased sensitivity for easier detection of smaller vessels and calcified arteries
- An EZ8 wide beam probe for easy vessel location
- A reusable intraoperative probe for cost effective reassurance during surgery
- Improved, audio performance, battery power management, carry bag design which includes space for a sphyg and cuff

EZ8 PROBE: The new 8MHz high sensitivity EZ8 doppler probe incorporates Wide Beam technology to allow easy location of the vessel. It is also easier to maintain vessel contact during inflation and deflation.

VP4HS: The 4MHz high sensitivity doppler probe for detection of deep lying vessels.

VP5HS: The 5MHz high sensitivity doppler probe for edematous limbs and deep lying vessels. The ideal probe as an adjunct to the EZ8 for ABI measurements.

VP8HS: The 8MHz high sensitivity doppler probe for easier detection of peripheral vessels and calcified arteries.

VP10HS: The 10MHz high sensitivity doppler probe for detecting smaller vessels in superficial applications.

IPP3: The 8MHz Resterilizable Intraoperative probe. Ideal for most surgical applications.

HUNTLEIGH DOPPLER ACCESSORIES

CODE	DESCRIPTION
10081	Huntleigh Doppler Fetal Probe
10247	Huntleigh Doppler Probe VP4HS
10295	Huntleigh Doppler Probe VP5HS
10045	Huntleigh Doppler EZ8 Probe
10163	Huntleigh Doppler Probe VP8HS
10233	Huntleigh Doppler Probe VP10HS
10202	Huntleigh Interoperative



D920 FETAL DOPPLER

Audio only doppler

This audio doppler has been designed with ease of use in mind. Its high sensitivity transducer coupled with clear fetal heart sounds, enable the clinician to quickly locate the fetal heart.

- High sensitivity ultrasound for improved ease of use
- 2MHz waterproof transducer suitable for use in a water birthing environment
- Battery low indicator
- Easy clean transducer for improved infection control
- Belt clip and neck-cord (option) to aid handling

D920 FETAL DOPPLER

CODE	DESCRIPTION
10046	Huntleigh Fetal Doppler D920



FD1 FETAL DOPPLER

Waterproof rate display doppler

The FD1 is a highly versatile obstetric doppler, with the added advantage of displaying the fetal heart rate. The high performance transducer enables reliable detection from early gestation right through to delivery, even on obese patients.

- Advanced real time auto-correlation fetal heart rate processing
- Active noise reduction for crystal clear fetal heart sounds
- 2MHz waterproof transducer suitable for use in a water birthing environment
- Advanced power management with auto switch-off to conserve battery life
- Long robust coiled cable enables optimum transducer position in all circumstances

POLE STAND ACCESSORY

A convenient way of holding your hand-held doppler and preventing it from disappearing into other departments.

- Options for both hand-held and desktop dopplers
- Provides convenient and height adjustable secure mount on mobile 5 wheel base
- Includes basket for storing gel, probes, cuffs, etc
- Option to mount Dopplex® Printa II on pole below doppler

FD1 FETAL DOPPLER

CODE	DESCRIPTION
10047	Huntleigh Fetal Doppler FD1

POLE STAND

CODE	DESCRIPTION
10160	Huntleigh Doppler Stand

HUNTLEIGH ABILITY

DOPPLEX ABILITY

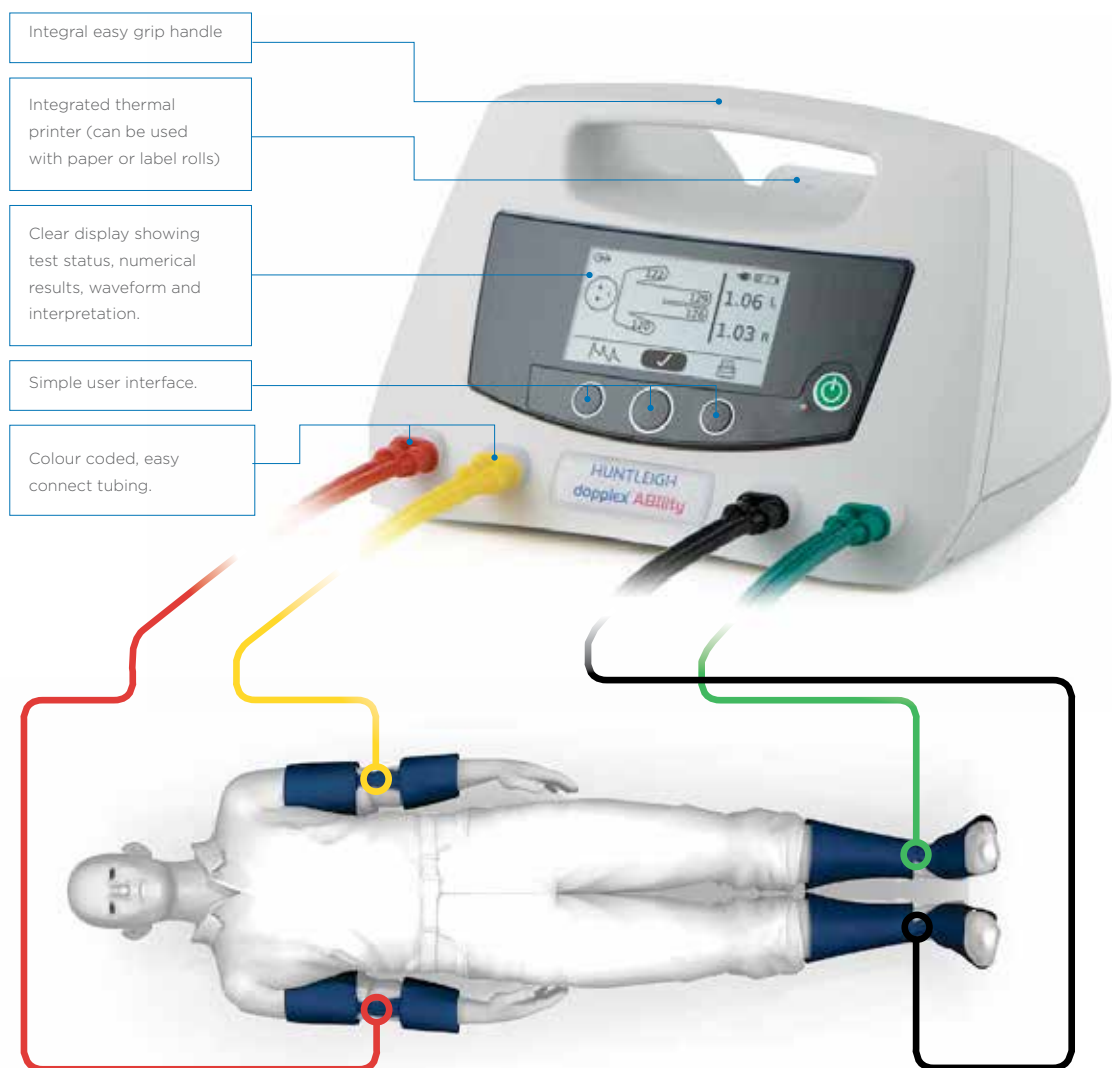

AUTOMATIC ANKLE BRACHIAL INDEX SYSTEM

Revolutionising Ankle Brachial Pressure Index Measurements

Ankle Brachial Index System has never been simpler or quicker. It's portability enables measurements to be made more efficiently in the primary care clinic, hospital or patient's home. This can lead to the prioritisation of clinical services by improving clinical pathways.

ABIs are calculated easily and accurately in three minutes without the need to rest the patient. Results are automatically calculated, interpreted and displayed with Pulse Volume waveforms on the LCD panel. The test results can be printed on either thermal paper or adhesive backed label paper via the integral printer.

AUTOMATIC ANKLE BRACHIAL INDEX SYSTEM

CODE	DESCRIPTION
11296	Huntleigh Ability Unit
11298	Huntleigh Ability Carry Bag
11297	Huntleigh Ability Trolley
11302	Huntleigh Ability Fixing Plate
11301	Huntleigh Ability Label Paper
11300	Huntleigh Ability Paper
11299	Huntleigh Ability Sleeves
12876	Huntleigh XL Cuff Set



EAGLE FIXED AND MOBILE SHELVING



EAGLE STORAGE SOLUTIONS

Eagle provides a vast range of storage solutions designed around maximising space, improving ergonomics, processes and work flows. In healthcare environments today, storage space is often at a premium. It is not uncommon to out grow storage areas due to increased clinical workload. Eagle's shelving can provide solutions for any new rebuild, taking into consideration the needs of today, while allowing the flexibility for change and growth in the future.

Our solutions can be tailored for any clinical area including:

- Theatre
- Sterile supply services
- Wards
- Linen departments

Solutions include:

High density storage solutions

- Floor track solutions: running on bearings and only protruding 1 cm from the floor, this new product from Eagle offers many benefits

These include:

- No fixed ends increasing the number of available pick faces
- The ability to store up to 900kg on one mobile unit
- Provides optimal storage when there is minimal space available
- Ergonomically friendly and easy to manoeuvre mobile units
- Overhead track storage solutions: offering similar benefits to the floor track system, the overhead solution has fixed ends with mobile units that run on castors. Each mobile unit can store up to 450kg

Shelving

Available in a wide range of sizes and finishes, USL will be able to provide a suitable product for any clinical area or requirement. Finishes include stainless steel, zinc, chrome and expozay finishes.

Wire carts

Mobile shelving solutions designed around reducing double handling and improving work and process flows.

FOR MORE INFORMATION CONTACT:

USL MEDICAL CUSTOMER SERVICES ON 0800 658 814

Accessories

A range of various accessories are available to help utilise storage space. These include:

- Tote bins
- Shelf dividers
- Shelf ledges
- Storage baskets
- Cart covers

Contact your USL Representative for a free measure and quote or for advice on how to best utilise your storage space.

Case Carts

Available in a range of sizes with adjustable shelving heights.



MEDICAL & SURGICAL
CARTS/TROLLEYS



HERMAN MILLER MEDICAL AND SURGICAL PROCEDURE CARTS

Herman Miller provides a wide range of carts for every clinical need. These include:

- Anaesthetic carts
- Resuscitation carts
- Airway carts
- Procedure carts
- Medication trolleys
- Linen carts
- Catheter carts
- Laptop trolleys
- Endoscopy carts

Herman Miller carts are designed to fit in with, or improve the processes and tasks that we complete every day. When choosing a cart solution we take into consideration work processes, function, storage and transport flow. Solutions are focused on:

Standardisation

Ensuring in an area where multiple carts are used, that the carts are all configured identically so staff have complete familiarity in emergency and day to day situations.

Flexibility

Over time, processes and products change. These changes can affect the suitability of a custom made product. All Herman Miller carts allow for their configuration to be changed, meeting the needs of the day.

Functionality and modularity

Drawers and accessories are all interchangeable. Create the function you need with a combination of specific interior components. Recreate new styles or functionality by exchanging components.

Durability

All of the carts are made of highly durable impact-resistant plastic. Colour is integrated into the plastic so there is no colour chipping even if surfaces are scratched. The carts are put through rigorous tests to ensure they meet the needs of a fast paced hospital environment. This includes tipping them, pushing them into walls at high speed, loading them to capacity and ensuring drawers won't fall out.



**FOR MORE INFORMATION CONTACT:
USL MEDICAL CUSTOMER SERVICES ON 0800 658 814**

Value

Herman Miller carts are guaranteed for 10 years... that's 87,600 hours of constant use...and then some.

Mobile technology laptop carts are guaranteed for 5 years.

Cart design

There are many factors to consider when designing your cart. The team at USL will work with you to ensure the appropriate accessories are provided to ensure complete functionality. Accessories include:

- Flip up shelf
- IV pole
- Defib tray
- Glove holders
- Electrical outlet box
- Above cart storage bins
- Sharps holder
- Oxygen tank holder
- Catheter racks
- Waste baskets
- Cord holder
- Chart holder
- Above cart shelf
- Containers and dividers
- Lockable drawers/carts

HERMAN MILLER HEALTHCARE ENVIRONMENT SOLUTIONS

Providing adaptable modular sections for all areas including:

- Nurse stations
- Family areas
- Patient rooms
- Pharmacy
- Laboratories
- Administration areas

Designed around the needs of today and can be adapted for the needs of tomorrow. Solutions include design and installation.

Speak to a USL representative to learn more about the Herman Miller product offerings.



STAINLESS STEEL TROLLEYS

Two shelves one lockable drawer

- 490L - 490W - 900H
- Stainless steel

Two shelves two lockable drawers

- 490L - 490W - 900H
- Stainless steel

Two shelves

- 490L - 490W - 900H
- Stainless steel

Two shelves larger trolley

- 800L - 500W - 900H
- Stainless steel

CODE	DESCRIPTION	SIZE (MM)
WMWPH701	Trolley S/S 2 Shelves	490L - 490W - 900H
WMWPH702	Trolley S/S 2 Shelves/1 Drawer	490L - 490W - 900H
WMWPH703	Trolley S/S 2 Shelves/2 Drawers	490L - 490W - 900H
WMWPH705	Trolley Large S/S 2 Shelves	800L - 500W - 900H
WMWPH706	Trolley S/S 2 Shelves	490L - 490W - 900H
WMWPH707	Trolley S/S 2 Shelves	900L - 500W - 900H
WMWPH708	Trolley S/S 2 Shelves/No Rails	500L - 1100W - 900H
WMWPH709	Trolley S/S 2 Shelves/With Rails	1200L - 600W - 900H
WMWPH710	Trolley S/S 2 Shelves/No Rails/2 Drawers	700L - 490W - 900H

 **Liko**
A **Hill-Rom** Company



HOISTS

- MOBILE
- HOISTS AND PATIENT TRANSFERS
- SLINGS

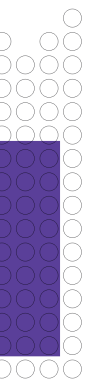



VIKING

For the most demanding lifts

Aluminium was the natural choice of material for Viking, not only for aesthetic reasons, but mainly because it makes your lift easier to manoeuvre. Aluminium also has a number of environmental advantages. Aluminium can be reused again and again, and recycling requires relatively little energy.

VIKING - XS

Ideal where space is extremely limited

A small and extremely narrow mobile lift, specially developed for settings with narrow doorways or where lifting space is particularly restricted.

Viking XS is a stable and reliable mobile lift that is ideal in most common lifting situations - eg, to and from the toilet, between bed and wheelchair, or for lifting to and from the floor.

Important features:

- Made of aluminium, good lifting capacity in relation to weight
- Total width 54cm, passes easily through the narrowest doorways

VIKING - S

Small but strong

A small, easily manoeuvred mobile lift that performs superbly in relation to its diminutive size and low overall weight - perfect in settings where space is limited

VIKING - M

The all-round lift

After 25 years of market-leading product development, we know how to design the optimal mobile lift. Viking M has most of the best features and is ideal for the most common lifting situations.

VIKING - XL

For the most demanding lift

Lifting heavy patients entails great responsibility. Although Viking XL has been specially developed for very heavy patients, it is also suitable for average-sized people. Despite its size, Viking XL weighs only 43kg and is very easy to handle.

VIKING

CODE	DESCRIPTION	SWL	WEIGHT	LIFTING HEIGHT
L2040007	Viking XS	160 Kg	25 Kg	155 Cm
L2040006	Viking S	160 Kg	25 Kg	175 Cm
L2040015	Viking M	205 Kg	34 Kg	179 Cm
L2040033	Viking XL	300 Kg	42 Kg	187 Cm



SABINA II EE

Sit-to-stand hoist, three lifts in one

Sabina differs from other sit-to-stand lifts. The well-thought-out accessories give several different possibilities in one single lift. And being able to adapt a raising motion or a lifting situation according to the patient's abilities obviously gives a better result than using the same solution for all patients. Sabina has easily exchanged sling bars. The most common is the narrow sling bar (Slingbar 350) which is used with the Liko SupportVest or Liko SafetyVest. Patients who have pressure-sensitive armpits use the Comfort Slingbar and ComfortVest. Sabina can also, to a limited extent, be used as a lift for lifting sitting patients (so called passive lifting). Lifting capacity: 200kg



GOLVO

The world's most versatile healthcare lift

Sometimes it can be difficult to choose between a mobile lift and an overhead lift. Golvo gives you both. Together with Liko's comprehensive range of functional slings and accessories, Golvo is the perfect lift for every situation, including the challenges of gait training and horizontal lifting.

Golvo features:

- Vertical lifting, the easiest and most logical lifting motion
- Flexible lift strap, adjusts the lift for the person being lifted
- Slingbar with safety latches enhances safety
- Swivelling armrest to give the patient more reassurance and the caregiver greater leverage for manoeuvring
- Parallel, equilateral base-width adjustment for easy access to wheelchairs and beds
- Electrical emergency lowering and raising
- Mechanical emergency lowering for safe and easy lowering
- Built-in charger. Charge the batteries simply by plugging the charger cable into a wall socket
- Anodized aluminium. The right choice of material from all viewpoints: environmental, quality, design, light weight and corrosion resistance
- Lifting capacity: 200kg (440lbs)



SABINA II EE

CODE	DESCRIPTION
L2020003	Sit-to-stand Hoist
L2027002	Sabina II 350 Sling Bar
L2027003	Sabina II Comfort Sling Bar

GOLVO

CODE	DESCRIPTION
L2000035	Golvo Hoist, includes Charger

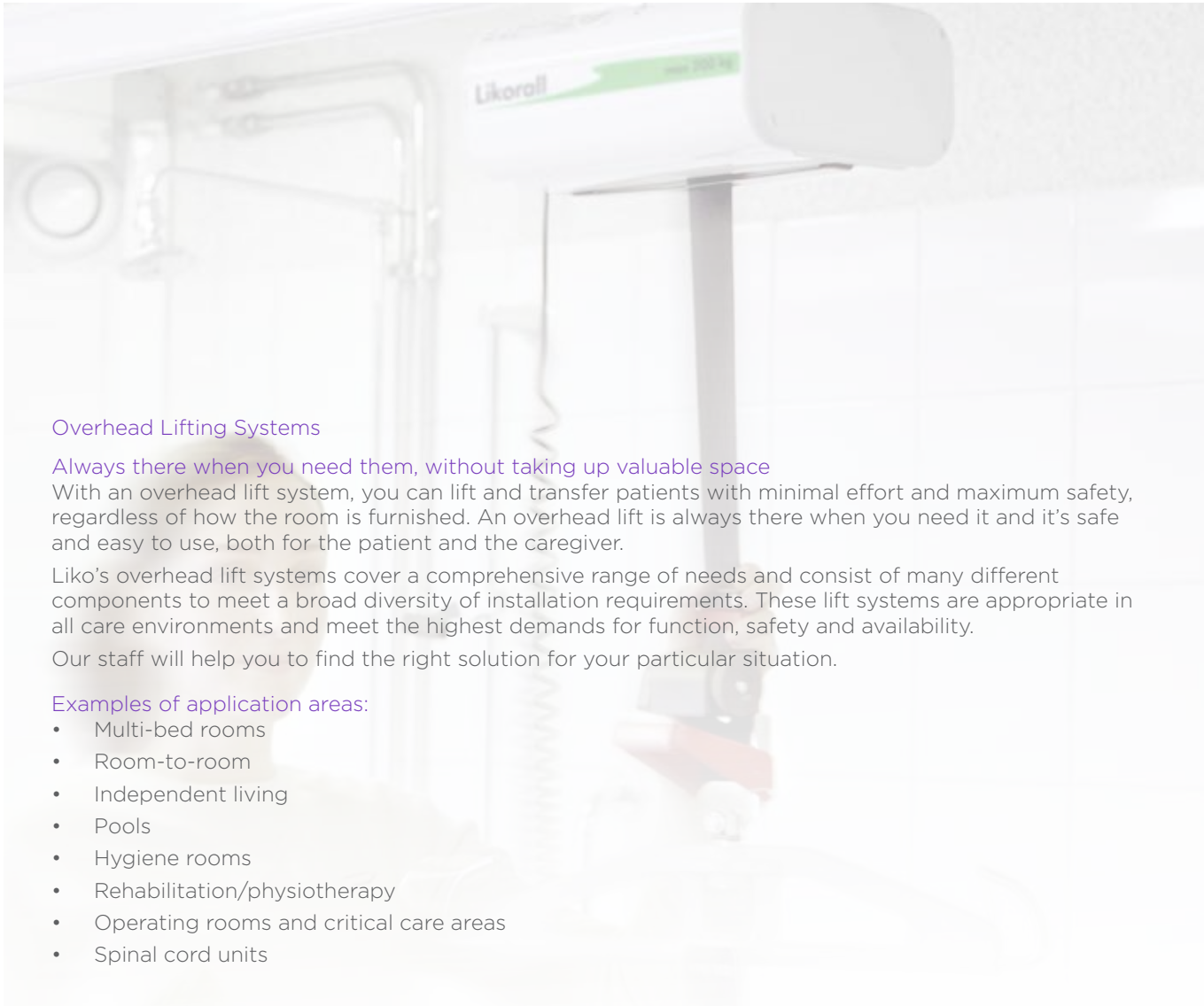

Overhead Lifting Systems

Always there when you need them, without taking up valuable space

With an overhead lift system, you can lift and transfer patients with minimal effort and maximum safety, regardless of how the room is furnished. An overhead lift is always there when you need it and it's safe and easy to use, both for the patient and the caregiver.

Liko's overhead lift systems cover a comprehensive range of needs and consist of many different components to meet a broad diversity of installation requirements. These lift systems are appropriate in all care environments and meet the highest demands for function, safety and availability.

Our staff will help you to find the right solution for your particular situation.

Examples of application areas:

- Multi-bed rooms
- Room-to-room
- Independent living
- Pools
- Hygiene rooms
- Rehabilitation/physiotherapy
- Operating rooms and critical care areas
- Spinal cord units

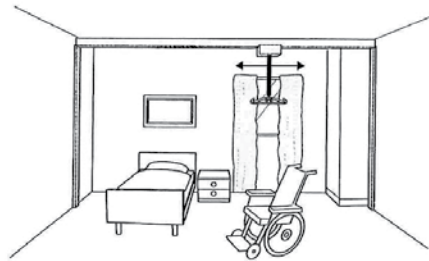

Fixed rails for transfer between fixed points

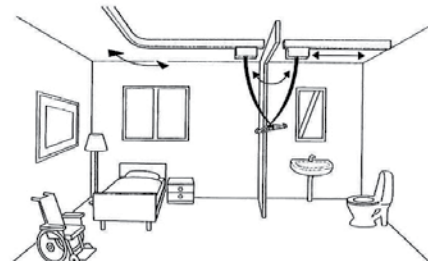

Room-to-room alternatives

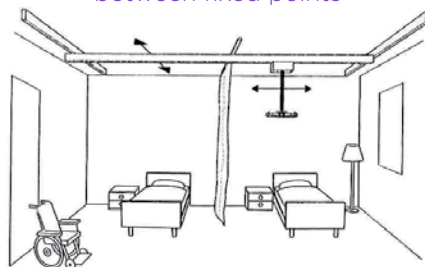

Traverse systems for transfer anywhere in the room



Freestanding solutions

OVERHEAD LIFTING SYSTEMS

CODE	DESCRIPTION
N/A	Call for sizing and codes



ULTRATWIN

The heavy duty overhead system for the heaviest patients

With a lifting capacity of up to 460kg (1,014lbs), UltraTwin is designed for the heaviest lifting situations. Its two interacting lift motors let the caregiver both lift and position the patient to different sitting postures during the lift. UltraTwin can be installed permanently in a room or freestanding in FreeSpan. UltraTwin FreeSpan can be mounted either as a Straight Rail or as a Traverse system. The many different rail-lengths make it possible to fit the system in different types of rooms.

- Maximum load: 400-460kg (880-1,014lbs)
- Lift motors: 2 Likorall or Multirall

UltraTwin
Freespan

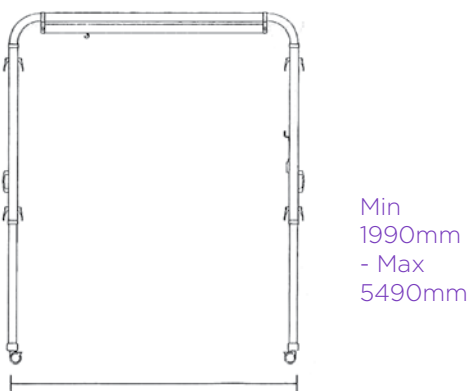
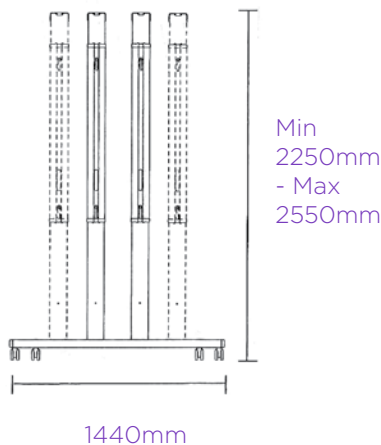

ULTRATWIN

CODE	DESCRIPTION
TBA	Call for sizing and codes

FREESPAN

Straight Rail or Traverse - the choice is yours

FreeSpan is the flexible alternative for most stationary-lift situations. The lift system is freestanding, and since it is not affixed to the walls or the ceiling, there are no special strength requirements for those structures.

FreeSpan is available in two versions, Straight Rail (SR) and Traverse (H-system). Choose between Multirall and Likorall lift units. FreeSpan is made of aluminium and many different rail-lengths are available.

FreeSpan SR is assembled without tools. The lift system can be easily moved between rooms. FreeSpan SR is equipped with wheels, which facilitate positioning and make it easier to clean the room.

FreeSpan Traverse is a freestanding gantry-type system that enables lifting and transfer of patients between many different lifting points. The lift unit can be easily moved in all directions over a large area.

FreeSpan features:

- Straight Rail or Traverse (H-system)
- Several different rail-lengths
- Easily adjustable height and width
- Made of light-weight, extruded aluminium. The right choice of material from all viewpoints: environmental, quality, design and corrosion
- Max load: 200kg (440lbs)

FREESPAN

CODE	DESCRIPTION
N/A	Call for sizing and codes



MULTIRALL

A versatile overhead lifting system

Liko's quick-release hook system is the key to Multirall's flexibility. Multirall is just as appropriate for occasional lifting needs as it is for long-term ones. As a simple, portable overhead lift that does not compromise on safety or function, Multirall is unbeatable. In addition, Multirall works perfectly as a room-to-room lift.

Installation alternatives:

- Multirall can be installed on the carriage in two different ways. No tools are required
- Mounting in the motor-up position, directly to a rail carriage, enables the Multirall to function as a normal overhead lift
- Mounting in the motor-down position, with varying connection heights, enhances both portability and room-to-room capabilities with only one motor

Multirall features:

- A versatile lift that can be used in many different ways.
- Easy to move; no tools are required
- Practical accessories; trolley, helping hand
- Big handles on both sides of the lift give a good grip when transporting a patient or when moving the lift to another place
- Complete rail system including the possibility to be used in the freestanding FreeSpan
- Can be used with a wide range of Liko's accessories
- Lifting capacity: 200kg (440lbs)



Multirall Trolley: Convenient trolley for transfer, assembly and storage of Multirall and accessories.

MULTIRALL AND MULTIRALL TROLLEY

CODE	DESCRIPTION
L3130001	Multirall 200
L3136300	Multirall Trolley



AIRPAL® PATIENT TRANSFER SYSTEM

Research shows us that from an injury-reduction perspective, using the right combination of beds, surfaces and lifting equipment in combination with evidence-based training is the most effective way of preventing low-back injuries.

- Allows safe, easy horizontal transfers
- Moves patients on a smooth surface of air
- Reduces risk of caregiver back injuries
- Transfers all patients, regardless of weight
- Weight capacity up to 544kg
- This type of cost-effective device reduces friction and is favoured by many caregivers to perform lateral transfers

APAS1100	AIRPAL Air Supply
APO700-2	AIRPAL Transport Stand Double
APO700-1	AIRPAL Transport Stand Single

PREMIUM-VALUE-REUSABLE TRANSFER PAD SWL 500KG

SURE CHECK FUSION COVER - LAUNDERABLE

APO28N	AIRPAL Transfer Pad 28"
APO32N	AIRPAL Transfer Pad 32"
APO39N	AIRPAL Transfer Pad 39"
APO50N	AIRPAL Transfer Pad 50'
APO39NSH	AIRPAL 1/2 size 39'
APO32NSH	AIRPAL 1/2 Size 32'

LECTROLITE COVER - WHEN EXCESSIVE FLUIDS ENCOUNTERED

APO28L	AIRPAL Transfer Pad 28"
APO32L	AIRPAL Transfer Pad 32"
APO28LSH	AIRPAL 1/2 Size 28"
APO32LSH	AIRPAL 1/2 size 32"

RE-USABLE LINERS

APO39SN	AIRPAL Sanilliner for 39' Pad
APO50SN	AIRPAL Sanilliner for 50' Pad

SINGLE- PATIENT-STAY DISPOSABLE SWL 450KG AFE

APO34SPS	AIRPAL SPS Transfer Pad 34"
APO39SPS	AIRPAL SPS Transfer Pad 39"



WEEVAC TC® PATIENT TRANSFER SYSTEM

The WEEVAC TC is designed for adults and older children. It has proven to be invaluable in the fast and secure evacuation of hospitals, nursing homes and chronic care facilities. Allows safe, easy horizontal transfers.



Its one-piece construction is fully adjustable to snugly and securely cocoon patients of any size in a heat insulating, protective layer of waterproof mylar laminated vinyl.



A special fabric covers the bottom to facilitate sliding patients on all floors and stairs. The WEEVAC TC is only as wide as the patient, essential in narrow hallways and stair-wells. Two long front straps allow your staff to face forward while pulling the patients.



The WEEVAC TC cocoons a patient in a heat insulating, waterproof system that provides secure storage for a patient's chart and any additional equipment. In comparison, the blanket above has no handholds to facilitate carrying a patient, cannot protect or secure a patient's chart and is not weather proof.

Weight	2.35 kg
Length open	396.5 cm
Width	74 cm
Roll Diameter	13 cm

WEEVAC TC®

CODE	DESCRIPTION
NO CODE	WeeVac® TC



WEEVAC 6® BABY TRANSFER SYSTEM

The only stretcher in the world designed to carry six bundled babies to safety in size-adjustable, heat retaining pockets.

FOR MORE INFORMATION CONTACT:
USL MEDICAL CUSTOMER SERVICES ON 0800 658 814

Weight	3.6kg
Length Open	188cm
Folded	94cm
Width	43.2cm

WEEVAC 6®

CODE	DESCRIPTION
10437	WeeVac® 6 Baby Transfer System



A Hill-Rom Company

Design Focusing on Safety, Function and Comfort.

Our slings are known for having high quality. For thirty years, in close cooperation with users and patients, we have developed functional and easy-to-use lifting accessories, always with the focus on safety, function and comfort.

World-Class Documentation.

Instruction Guides describing the sling's application are included with each sling. Here, guidelines will help you to determine which sling bar is best suited.

A Quick Reference Guide is available for all basic models. These brief instructions contain the most important information on the application and care of the sling.

The Fitting Protocol facilitates fitting, since it allows the caregiver to fill in current settings for a specific patient.

A Periodic Inspection Protocol is available to facilitate periodic inspection. These describe thoroughly which critical items need checking.

Did you know ...

... that choosing the right material is an important link in the chain when selecting a sling. Our slings are fabricated in different materials, each of which has special characteristics and advantages. The most common is the **green polyester fabric**, which is optimal with regard to wear resistance and durability. For bath and shower situations we recommend a sling in **plastic-coated net**, which dries quickly. When the sling is to be left in place, the net polyester, available in two grey qualities and one green, is preferable. Our Solo[™] material for disposable slings is unique, as it is made of a very strong **non-woven material**. Many of the smallest sizes of our slings are specially designed for children and are made of a **teddy-patterned polyester fabric**.

Our lifting accessories are approved for 200 kg (440 lbs) maximum load unless otherwise specified.

Tested and Approved.

Liko[™] slings have been tested by an accredited testing institute and comply with all requirements for MDD Class I products. They also comply with all requirements in accordance with harmonized standards EN ISO 10535-2006. Our lifting accessories are approved for a maximum load of 200 kg (440 lbs) unless otherwise specified, but we also have slings with a maximum load of 500 kg (1100 lbs) in our wide sling range.



Do not use damaged lifting accessories!



1. Product Label which clearly states the sling model, size and design. Here, you also find laundry advice and maximum load for the sling.

2. Patient Marking Label, sewn onto the sling. Space for five different names is provided.

3. Periodic Inspection Label for marking inspection dates. You simply make a hole in the appropriate square to mark the current month and year. This provides for a durable marking which does not disappear during laundering.

4. Thoroughly tested **reinforced seams** (bartacks) and reinforced straps for optimum strength and safety. The reinforced seam, which is load tested, is placed where the increased load occurs. Placement of the seam has been determined through careful testing.

5. Size Markings in different colours. On most of the sling models this colour marking is placed as a middle back strap which also facilitates the correct application of the sling on the patient.

6. The slings are available in many carefully **selected materials** to function optimally in different application areas.

7. Leg Supports in many different designs – fabric only, padded and reinforced to meet all different needs. Wide and long leg supports provide an optimum support area for maximum comfort and pressure relief.

8. Edgings sewn in a single piece, with few joints to ensure maximum strength, since seams are the weakest link.

Our sling models are **carefully designed** to ensure that the patient sits with pressure well-distributed between legs and back section for good support during transfers. This enables an optimal sitting posture, so that the patient ends up in the right place during transfers.



Slings for Patient Needs.

For many years we have adhered to the motto “*The Sling is Half the Lift*”. The sling is the determining factor for how well the lift is performed; it is the link between the lift and the patient. All sling models have unique characteristics to meet a wide range of specific lifting needs. Some sling models are called basic models because they cover a wider need for lifting different patients. These are used for common lifting situations, such as lifting from/ to bed/stretcher/chair/wheelchair. Some can also be used when lifting from the floor.

Did you know ...

... that no lift is like another. It is exactly for that reason that we have one of *the widest ranges of lifting accessories*. Each of our sling models has unique features to meet specific lifting needs. With our spectrum of slings and accessories we can provide for both the *most common lifts on a care unit and the more demanding special cases*. These considerations have guided us in our *development work for more than 30 years*. We venture to say that we know what works.



LIKO™ UNIVERSAL SLING™, MOD. 000, 002

A basic model which fits most patients. The Universal Sling is excellent for older patients with limited mobility. It enables an upright sitting posture with support for the entire back. Mod. 002 is a version that gives extra high lifting height. An excellent sling to start with.

- Excellent basic model, suits most patients
- Gives support for the whole back
- The patient's arms are positioned inside the sling
- Gives an upright sitting posture (000)
- Mod. 002 gives extra lifting height

SIZES: S, MS, M, L, XL*

FABRICS: Polyester, net polyester, plastic-coated net



LIKO™ SOFT ORIGINAL HIGHBACK SLING™, MOD. 26 BESTSELLER

Liko™ Soft Original HighBack Sling™ has a developed fit and comfort with convenient head rest in seated position. It enables a reclined sitting posture with support for the head and is therefore suitable for patients with poor head and torso stability. Soft Original HighBack Sling™ is very suitable for lifting to and from the floor.

- Suits most patients
- Best choice for transfers from horizontal (lying) position
- Optimized fit and comfort
- Provides extra comfortable support for the head
- Comfortable reclined sitting posture

SIZES: XS, S, MS, M, L, XL, XXL*

FABRICS: Polyester, teddy-patterned knitted polyester (children)



LIKO™ ORIGINAL HIGHBACK SLING™, MOD 20

Liko™ Original HighBack Sling™ enables a reclined sitting posture with support for the head and is therefore suitable for patients with poor head and torso stability. It is very suitable for lifting to and from the floor.

- Suits most patients
- Excellent choice when lifting from a flat position
- Gives good support for back and head
- Comfortable reclined sitting posture

SIZES: XS, S, MS, M, L, XL, XXL*

FABRICS: Net polyester, plastic-coated net, polyester, teddy-patterned knitted polyester (children)



LIKO™ ORIGINAL SLING™, MOD. 10/11

Liko™ Original Sling™ has a medium-high back which allows the patient to hold one or both arms outside the sling. The sling fits the active user; it is simple and supple to work with and enables a comfortable sitting posture. Furthermore, it is available in a wide assortment of sizes and versions.

- Allows patient participation
- Excellent for transfers from sitting to semi-reclining
- Excellent back support up to shoulder blades
- The patient may rest the arms on the inside or outside
- Easy to apply

SIZES: XS, S, MS, M, L, XL *

FABRICS: Polyester, net polyester, plastic-coated net, teddy-patterned knitted polyester (children)





Assistance When You Need it Most.

Lifting in connection with toilet transfers requires more from a sling. Our slings facilitate easy dressing/undressing of the patient during the actual lifting procedure. These lifting operations are often perceived by caregivers as difficult and awkward. Our range, with several different models which provide different levels of support and safety, eases the pressure for everybody.



LIKO.. HYGIENE SLING.. MOD. 40, 41

BESTSELLER

A simple and easy-to-use sling which suits most patients. It facilitates dressing/undressing for transfers to and from the toilet. The sling is suitable for patients with a certain degree of body stability. Hygiene Sling.. mod. 41 is equipped with a belt and has improved fit. Mod. 41 is an excellent sling to start with.

- For patients with good torso stability
- Easy to apply
- Facilitates dressing/undressing during hygiene transfers
- The patient holds his/her arms outside the sling
- Mod. 41 is equipped with a belt for increased safety and security

SIZES: XS, S, M, L, XL *

FABRICS: Polyester, teddy-patterned knitted polyester (children)



SLINGS



LIKO.. HYGIENE SLING.. MOD. 45, 46

Hygiene Sling.. Mod. 45 is equipped with a SafetyBelt.. which lifts around the upper body for extra stability. Besides the SafetyBelt.., Mod. 46 is also equipped with an extra high back support.

- Equipped with SafetyBelt.., suitable for patients with poor torso stability
- Enables dressing/undressing during hygiene transfers
- Can be used with one of the patient's arms on the inside
- Mod. 46 is equipped with back support which provides extra support, safety and comfort

SIZES: XS, S, M, L, XL *

FABRICS: Polyester, teddy-patterned knitted polyester (children)



LIKO.. HYGIENE VEST.. MOD. 50, 55

The Hygiene Vest is a unique sling specially designed to safely and securely lift patients with low muscle tone to the toilet. The Hygiene Vest enables an upright sitting position, with firm support around the upper body. Simultaneously, it leaves a large portion of the lower body free for dressing/undressing. The Hygiene Vest Mod. 55 is equipped with head support.

Mod. 50:

- Suitable for patients with high/low tone and spasticity
- Facilitates dressing/undressing during hygiene transfers
- Supports and lifts around the upper body
- High security for hygiene transfers
- Upright sitting posture

SIZES: XXS, XS, S, M, L, XL, XXL, XXXL *

FABRICS: Polyester, teddy-patterned knitted polyester (children)

Mod. 55:

- Excellent for patients with spasticity
- Facilitates dressing/undressing during hygiene transfers
- Gives good support for back and head
- High security for hygiene transfers
- Supports and lifts around the upper body

SIZES: XXS, XS, S, M, L, XL

FABRICS: Polyester, teddy-patterned knitted polyester (children)



usl equipment

* Some sizes and designs with a max. load of 300 kg (660 lbs).

All Needs are Special, Some More than Others.

Our product line includes sling models which are more specialized to facilitate optimal use in a specific application area. Examples include lifting amputees or bariatric patients. To meet the need for slings for short-term use by a single patient, and as a way of avoiding the need for laundering, we have also developed a series of disposable slings. Thanks to our wide range, we can meet most needs.

We continuously work on developing new models and improving existing ones, which means we can offer customized slings for patients with very special needs.



LIKO™ AMPUTEE SLING™ MOD. 70, 75

The Amputee Sling has a special design with extra strap control which prevents the leg supports from sliding apart. We recommend the Amputee Sling for patients with high, double-sided leg amputations or other patients needing this extra security.

The Amputee Sling is available in two back heights; Mod. 70 supports up to shoulder height and Mod. 75 also supports the head.

- For patients with single or double-sided femoral amputations
- Suitable for patients who tend to slip out of other slings
- Gives excellent support for back and head (Mod.75)
- Slightly reclined sitting posture

SIZES: S, M, L, XL *

FABRICS: Polyester, net polyester





LIKO™ SOLO HIGHBACK SLING™ MOD. 25

To meet the need for slings for short-term use by a single patient, and as a way of avoiding the need for laundering, we have developed a series of disposable slings. The Solo High Back Sling™ is suitable for most patients and can be used for common transfers.

- Suits most patients
- Excellent choice when lifting from a flat position
- Gives excellent support for back and head
- Comfortable reclined sitting posture
- Disposable sling intended for single use (do not wash)

SIZES: MS, M, L, XL, XXL *

FABRICS: Nonwoven material



LIKO™ COMFORT SLING PLUS™ MOD. 300, 310

Comfort Sling Plus™ is a further development of the Comfort Sling™ (Mod. 30, 31) with improved comfort and fit. Comfort Sling Plus™ enables an upright sitting posture and support for the entire back.

Comfort Sling Plus™ is applied and removed with the patient in a supine position and is then left in the chair after the transfer. Model 310 is equipped with a hygiene opening.

- Excellent for patients with arthritis/leg amputation
- The sling is left in place under the patient
- Sling model with a possibility of open hip joint angle combined with a 4 point sling bar

SIZES: M, L, XL *

FABRICS: Net polyester, plastic-coated net



LIKO™ COMFORT SLING PLUS HIGH™ MOD. 350, 360

Comfort Sling Plus High™ is a further development of the Comfort Sling™ (Mod. 35, 36) with improved comfort and fit. Comfort Sling Plus High™ gives a slightly reclined sitting posture and support for the entire back. It is equipped with a soft head support. Comfort Sling Plus High™ is applied and removed with the patient in a supine position and is left in the chair after the transfer. Model 360 is equipped with a hygiene opening.

- Excellent for patients with arthritis/leg amputation
- The sling is left in place under the patient
- Sling model with a possibility of open hip joint angle combined with a 4 point sling bar
- Provides extra comfortable support for the head

SIZES: M, L, XL *

FABRICS: Net polyester, plastic-coated net



LIKO™ SILHOUETTE SLING™ MOD. 22

The Silhouette Sling™ provides a reclined sitting posture with comfortable head support. It is specially designed for transfers to narrow wheelchairs where the sling should be left in the chair. The Silhouette Sling™ is thin and pliable without handles or reinforcements.

- A pliable sling in net polyester for lifting to silhouettes and moulded seats
- Excellent for patients with postural deformities
- May be left under the patient after transfer
- Gives good support for back and head
- The patient may rest the arms on the inside or outside

SIZES: XS, S, M, L

FABRICS: Net polyester





Heavy Patients Become Lighter with the Right Aids.

Lifting heavy patients requires special aids and special technology. With a maximum load of up to 500 kg (1100 lbs), the Liko™ UltraTwin™ system can handle really heavy lifts. Thanks to two interacting lift motors, the patient can be placed in a seated, semi-reclining or horizontal position. By controlling the two lift motors individually, the sitting position can be adjusted for maximum comfort. Liko has extensive experience of working with overweight patients. For many years we have worked in close collaboration with several large hospitals around the world which specialize in the care and treatment of bariatric patients.



LIKO™ ULTRA SLING™, MOD. 06

The Ultra product series has been developed for lifting bariatric patients in a safe and comfortable way.

Ultra Sling™ supports the entire back up to the shoulders. With the unique design, the leg supports are installed individually on the sling bar, which gives the stomach space and the legs optimal support. Ultra Sling™ is available in three sizes, where Long also provides extended support for the lower legs.

- Designed for bariatric patients
- Provides extra space for the abdomen
- Can be used in combination with the Liko UltraTwin™ lift system, size Short can also be used with Universal TwinBar™ 670
- Max. load 500 kg (1100 lbs)

SIZES: Short, Regular, Long

FABRICS: Polyester, (net polyester)



LIKO™ SOFT ORIGINAL HIGHBACK SLING™, MOD. 26

Soft Original HighBack Sling™ has a developed fit and comfort with comfortable head support in the seated position. Soft Original HighBack Sling™ provides a reclined sitting position with support for the head and is therefore suitable for patients with poor head and torso stability. Soft Original HighBack Sling™ is ideal for lifting to/from the floor. The larger sizes of Soft Original HighBack Sling™ can be used to advantage for lifting heavier patients, preferably in combination with a Universal TwinBar™ 670, Sling Cross-Bar 670 or SideBars, depending on how much space the patient needs.

- Suits most patients
- Optimized fit and comfort
- Provides extra comfortable support for the head
- Comfortable reclined sitting posture
- Max. load 500 kg (1100 lbs)

SIZES: For patients weighing 200–500 kg (440–1100 lbs) sizes XL, XXL are available

FABRICS: Polyester



ULTRA LIFTPANTS™, MOD. 920

Getting heavy patients onto their legs is a very important step in their rehabilitation, for example, after an operation. The unique Ultra LiftPants™ give good support to the whole body and give the patient the confidence to take those first steps.

- For patients who can put weight on their legs
- Safe and secure for raising, standing, gait and balance training
- Allows natural pattern of movement when rising
- Takes the strain in the crotch and by the hip loop straps
- Accessories: Solo cover, padded cases for the shoulder straps
- Max. load up to 500 kg (1100 lbs)

SIZES: XXL, XXXL

FABRICS: Net Polyester

Other Accessories for Heavier Patients.

LIKO™ HANDYSHEET™

See page 21.

LIKO™ REPOSHEET™ ORIGINAL ULTRA

See page 22.

LIKO™ MULTISTRAP™

See page 23.

Secure Slings for Children.

Lifting children is not the same as lifting small adults. Children have special needs and therefore require products that are specifically designed to meet these needs. We have extensive experience in this area and were first in offering lifting accessories specially adapted for children. We continuously work on developing technology and models for our younger patients, and today most of our sling models are available in versions that are specially designed for children. Many of our pediatric models are available in a teddy-patterned fabric to appeal to the smallest. We call them “TeddySlings”.



TEDDYSLING ORIGINAL. LIKO.. ORIGINAL SLING., MOD. 10

This sling is suitable for lifting to/from a seated/semi-reclining position or from the floor if the child does not need special support for the head. Support the entire back up to the shoulders.

- Belt with SafetyBuckle

SIZES: XS, S

FABRICS: Teddy-patterned knitted polyester (children), polyester (S only), net polyester, plastic-coated net (S only)



TEDDYSLING SOFT ORIGINAL.. MOD. 26 LIKO.. ORIGINAL HIGHBACK SLING.. MOD. 20

These models enable a relaxed, reclined seated position. They can be used for all transfers to and from the horizontal and seated positions. Perfect for transfers to and from the floor. Mod. 26 is also equipped with a reinforced head section and allows a more upright seated position and excellent support for the patient. Children with spasticity problems often sit well in Mod. 26.

- Belt with SafetyBuckle
- Mod. 26 also has reinforcement in back, head and leg supports

MOD. 20: SIZES: XS, S

FABRICS: Polyester, net polyester, plastic-coated net

MOD. 26: SIZES: XS, S

FABRICS: Teddy-patterned knitted polyester (children)



LIKO.. SILHOUETTE SLING.. MOD. 22

We have developed the Silhouette Sling.. especially for children who sit in moulded seats and therefore need the sling to be left in the chair after the transfer. Their arms can be held inside or outside the sling.

- May be left in the chair after transfer
- Gives excellent support for back and head

SIZES: XS, S

FABRICS: Net polyester



**TEDDY HYGIENE SLING../LIKO.. HYGIENE SLING.. MOD. 41
TEDDY HYGIENE SAFETY SLING.. MOD. 46**

We developed these slings for transfers to and from the toilet, but they can also be suitable for other lifting situations. Mod. 41 is equipped with a belt, Mod. 46 has a SafetyBelt™ and extra back support for best comfort. Both models have soft padding under the arms and reinforced leg supports.

MOD. 41: SIZES: XS FABRICS: Teddy-patterned knitted polyester (children), polyester
MOD. 46: SIZES: XS FABRICS: Teddy-patterned knitted polyester (children)



**TEDDY HYGIENE VEST/LIKO.. HYGIENE VEST.. MOD. 50
TEDDY HYGIENE VEST HIGH BACK../LIKO.. HYGIENE VEST HIGH BACK., MOD. 55**

We developed these slings for transfers to and from the toilet, but they can also be used for other lifting situations where an upright and steady sitting position is desired. The vest lifts around the upper body, which prevents any tendencies for the child to collapse. Children with spasticity problems often sit well in Mod. 55.

- Reinforced leg supports
- Model 55 has a head support

MOD. 50: SIZES: XXS, XS FABRICS: Teddy-patterned knitted polyester (children), polyester (XS only)
MOD. 55: SIZES: XXS, XS FABRICS: Teddy-patterned knitted polyester (children), polyester



**TEDDYVEST../LIKO.. MASTERVEST.. MOD. 60
TEDDYVEST.. FRONT CLOSURE MOD. 64**

These models adapt to the child and lift around the upper body just enough to allow the child to stand to the best of his/her ability.

- Model 64 is equipped with SafetyBuckles in the front for width adjustment.
- Leg harness and padded casing for shoulder strap (pictured) are accessories.

MOD. 60: SIZES: XXS, XS FABRICS: Teddy-patterned knitted polyester (children), polyester (XS only)
MOD. 64: SIZES: XS FABRICS: Teddy-patterned knitted polyester (children)



TEDDYPANTS.. MOD. 92

TeddyPants in teddy fabric make standing training a pleasure under secure conditions. With the adjustable setting in the waist, the child gets good support around the torso.

- Padded with synthetic sheepskin against the stomach and in the crotch.

SIZES: XS
FABRICS: Teddy-patterned knitted polyester (children)



**TEDDYVEST FOR STANDINGSHELL..
LIKO.. VEST FOR STANDINGSHELL.. MOD. 67**

We have developed the Vest for StandingShell for the difficult lifting of a child in a standing shell from the floor to a standing position. The lift takes the entire weight, and the child is lifted securely, with comfortable support for the whole body and the head.

- Head support and padded leg harness included.

SIZES: XXS, XS, S
FABRICS: Teddy-patterned knitted polyester (children), polyester (S only)



Stand and Walk with the Freedom to Move.

Our lifting accessories for stand/gait/mobility training allow you to achieve objectives that are often difficult to reconcile, such as giving the patient physical training without the caregivers and nursing staff risking strain injuries.

During transfers or training, the lift takes all the weight, so that the patient and caregiver can devote all their attention to the task without having to worry about the consequences of a wrong step.



Did you know ...

... that our *springs for jump/gait training* give a “bouncy” walk and are used in combination with Liko. LiftPants. or Liko. MasterVest.. The springs are both amusing and stimulating for the patient.



LIKO™ MASTERVEST™ AMBULATION SUPPORT MOD. 60, 64

The vest facilitates sit-to-stand lifting of patients who are able to support their own weight once they are standing. MasterVest™ Ambulation Support is a good aid for standing, gait and balance training. When transferring to or from the toilet, the lower body is free for dressing/undressing. Liko™ MasterVest™ Ambulation Support with front closure, Mod. 64, allows patients to button/unbutton the vest by themselves. The leg harness is available as an accessory in sizes for adults and children.

Mod. 60:

- For patients who can put weight on their legs
- Safe and secure for rising, standing, gait and balance training
- Allows natural pattern of movement when rising
- Excellent for hygiene transfers, lower body free
- Can be complemented with Leg Harness

SIZES: XXS, XS, S, M, L, XL, XXL *

FABRICS: Polyester, plastic-coated net (S, M, L only), teddy-patterned knitted polyester (children)

Mod 64:

- Same application areas as mod. 60
- With front closure
- Adjustable in the front for bust and stomach
- For independent patients
- Can be complemented with Leg Harness

SIZES: XS, S, M, L, XL, XXL

FABRICS: Polyester, plastic-coated net (M only), teddy-patterned knitted polyester (children)



LIKO™ LIFTPANTS™ AMBULATION SUPPORT MOD. 92

With Liko™ LiftPants™ Ambulation Support the patient can gait train under secure conditions. The LiftPants Ambulation Support provides freedom of movement, while relieving some or all of the burden of body weight. It supports safely, allowing the patient to move on his/her own without the risk of falling.

- Relieves the burden of body weight during standing and gait training
- Helps the patient with poor leg function to “walk”
- Allows great mobility in the room
- LiftPants are available in various sizes. All sizes, except the XS, are made of net polyester with a pressure-relieving padded crotch. A heavy person may need a bigger size than a thin person of the same height.

SIZES: XS, S, M, L, XL*

FABRICS: Net polyester, teddy-patterned knitted polyester (children)



LIKO™ VEST FOR STANDINGSHELL™ MOD. 67

A standing shell is much appreciated as an aid for disabled children and youths. However, applying the standing shell manually and raising the child in it can be very strenuous for the caregiver. But with the right lifting aids, these problems can be avoided.

- Allows patient participation
- Lifting a patient wearing a standing shell from a horizontal to a standing position
- Valuable aid for the rehabilitation of children and youths
- Leg harness included
- Does not put weight on the standing shell

SIZES: XXS, XS, S, M, L

FABRICS: Polyester (S, M, L only), teddy-patterned knitted polyester (children, XXS, XS, S only)



Sit-to-Stand Transfers with the Sabina™ Lift.

The Sabina™ lift is an easy-to-use, versatile sit-to-stand lift intended for patients who are able to actively participate in the raising procedure. When standing, they can be moved to a wheelchair or to a toilet; this gives them *standing practice in connection with the transfer*.

Raising is aided by a support vest which lifts the patient's upper body. Several different types of support vests are available to meet the needs of different patients. For example, the vest can be placed under or outside the patient's arms. Sabina™ lift has a wide range of different vest models and accessories.





LIKO™ SUPPORTVEST™ SIT-TO-STAND AID MOD. 91

BESTSELLER

Liko™ SupportVest™ Sit-To-Stand Aid is a comfortable sit-to-stand vest which is simple to use and requires little individual setting. It is used for patients who need a lot of help to raise themselves but who can then stand firmly on their own legs. It lifts behind the back and under the arms. The SupportVest™ Sit-To-Stand Aid can be used with or without sheepskin padding; the inside of the vest is corduroy-lined and prevents gliding. It has removable sheepskin padding which is attached with zippers. Extra padding is available as an accessory. It is attached around the body with an adjustable waist belt, which is intended to hold the vest in place during application. This model is an excellent sit-to-stand vest to start with.

- Fastened around the body with a belt
- Comfortable with removable padding
- Adjustable waist belt
- Used in combination with Sabina™ SlingBar 350
- Suitable for more stable patients
- Extension belt and extra padding available as accessories

SIZES: S, M, L, XL
FABRICS: Polyester, lined with corduroy



LIKO™ SAFETYVEST™ SIT-TO-STAND AID MOD. 93

LIKO™ SAFETYVEST™ SIT-TO-STAND AID WITH EXTRA BACK SUPPORT™ MOD. 94

The SafetyVest™ Sit-To-Stand Aid is a sit-to-stand vest which is unique in safety, form and function. It lifts behind the back and around the torso. The waist belt contributes to safety by preventing the risk of the patient sliding out. The safety principle in the tensioning devices of the vest means that we combine two interacting loops on each hook. (Same as on the MasterVest™ Ambulation Support, Hygiene Vest™ Therapy and Hygiene Sling™, Mod. 45/46). The SafetyVest™ Sit-To-Stand Aid is lined with plastic-coated net, which provides high friction and effectively prevents sliding. The SafetyVest™ Sit-To-Stand Aid with extra back support, Mod. 94 has higher back support and lower bottom edge, which distributes the pressure more softly over a larger area of the back. Suitable for patients with poor stability and difficulties standing.

- For extra safety/security
- Suitable for the patient with poor standing balance
- Mainly intended for use with the Sabina™ SlingBar 350
- Individual fitting
- Mod. 94 provides extra support behind the back
- Sheepskin padding available as accessory

SIZES: M, L
FABRICS: Polyester, padded with plastic-coated net.



LIKO™ COMFORTVEST™ SIT-TO-STAND AID MOD. 95

Liko™ ComfortVest™ Sit-To-Stand Aid differs in a principally decisive way from other sit-to-stand vests. It consists of two parts; the outer vest lifts behind the back and outside the arms and the inner waist belt, which is attached to the bottom edge of the outer vest, prevents sliding and thereby contributes to increased safety. The safety principle in the tensioning devices of the vest means that we combine two interacting loops on each hook (same as on the MasterVest™ Ambulation Support, SafetyVest™ Sit-To-Stand Aid, Hygiene Vest™ and Hygiene Sling™, Mod. 45/46). No part creates any pressure in the armpits, which makes this vest ideal for acutely sensitive and stroke patients.

- Suitable for patients with standing difficulties
- To avoid pressure under the armpits; e.g., for stroke patients and acutely sensitive patients
- Lifts behind the back and outside the arms - not under the arms
- Waist belt lifts around the torso and prevents slipping
- Individual fitting
- Used in combination with Sabina™ Comfort SlingBar

SIZES: S, M, L, XL
FABRICS: Polyester, padded with plastic-coated net.



LIKO™ SOLO SUPPORTVEST™ SIT-TO-STAND AID MOD. 911

Solo SupportVest™ Sit-To-Stand Aid is used when a sling for short-term use by individual patients is needed or when you want to avoid laundering. Used together with Liko™ Sabina™ Sit-to-Stand Lift to raise a patient from a seated to a standing position. Solo SupportVest™ Sit-To-Stand Aid lifts behind the back and under the arms.

- Intended for short-term use by individual patients from a sitting to standing position
- No laundry – discarded after soiling or completed use
- Used in combination with Sabina™ SlingBar 350

SIZES: M, L
FABRICS: Nonwoven material



FOR MORE INFORMATION CONTACT:
USL MEDICAL CUSTOMER SERVICES ON 0800 658 814

MATRESSES

Guide to Product Range Symbols

The Risk Categories contained in our product information correspond with the Waterlow Pressure Ulcer Prevention/Treatment Policy. Please note that all Pressure Ulcer Grading systems are not intended to be used prescriptively for equipment selection or replace clinical judgement which should always be the overriding factor in pressure ulcer prevention and treatment planning.



20+ Very High Risk Waterlow Score
Suitable for use with patients clinically evaluated to be at Very High Risk of developing pressure damage.



15+ High Risk Waterlow Score
Suitable for use with patients clinically evaluated to be at High Risk of developing pressure damage.



10+ At Risk Waterlow Score
Suitable for use with patients clinically evaluated to be At Risk of developing pressure damage.

Clinical Application

Our product range is designed to provide solutions for use on all categories of pressure ulcers, in the prevention and treatment stages up to and including category IV. Direct Healthcare Services mattress systems work in conjunction with good nursing procedures and in line with tissue viability protocols.

I



II



III



IV



Images supplied by the Welsh Wound Innovation Centre.



ACCUMAX™ QUANTUM™ CONVERTIBLE MATTRESS

The top of the line AccuMax™ Quantum™ Convertible is a non-powered pressure relief mattress that can be converted into a powered pressure relief mattress.

Some special features include a hand-crafted co-polymer and fibre topper, designed therapeutic pressure zones, plus a gentle heel slope.

These features all provide unsurpassed patient benefits and comfort.

The Convertible also includes our exclusive Airport™ connection system as standard equipment to allow quick and easy conversion to a powered system with gentle, alternating pressure capability - as easy as 1, 2, 3!

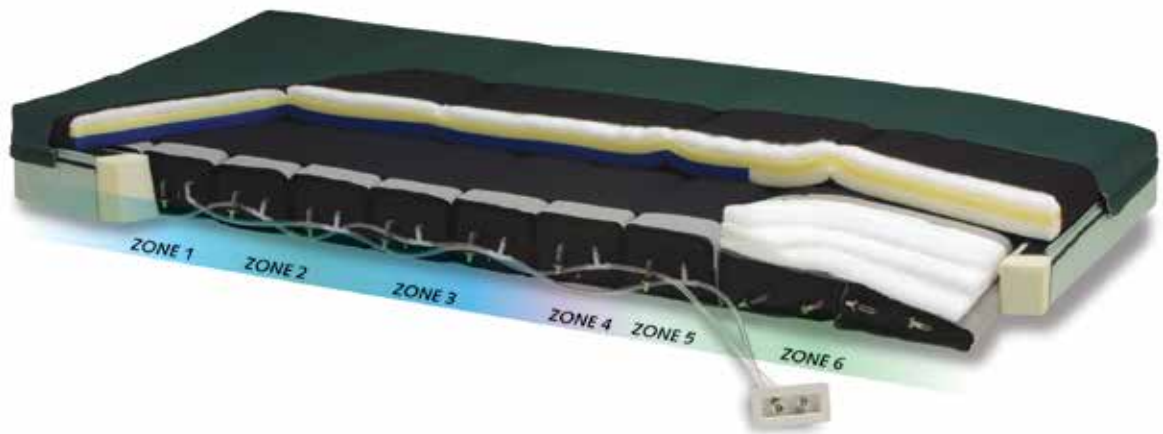

ACCUMAX™ QUANTUM™ CONVERTIBLE MATTRESS

CODE	DESCRIPTION	MEASUREMENT
90120	Accumax CU2 Pump	
90140	Accumax QC Mattress King Single	1066 x 2032
11253	Accumax QC Mattress Queen Size	1524 x 2032
90016	Accumax QC Mattress Single	890 x 1980
13984	Accumax QC Mattress Single	Turn Support Mattress

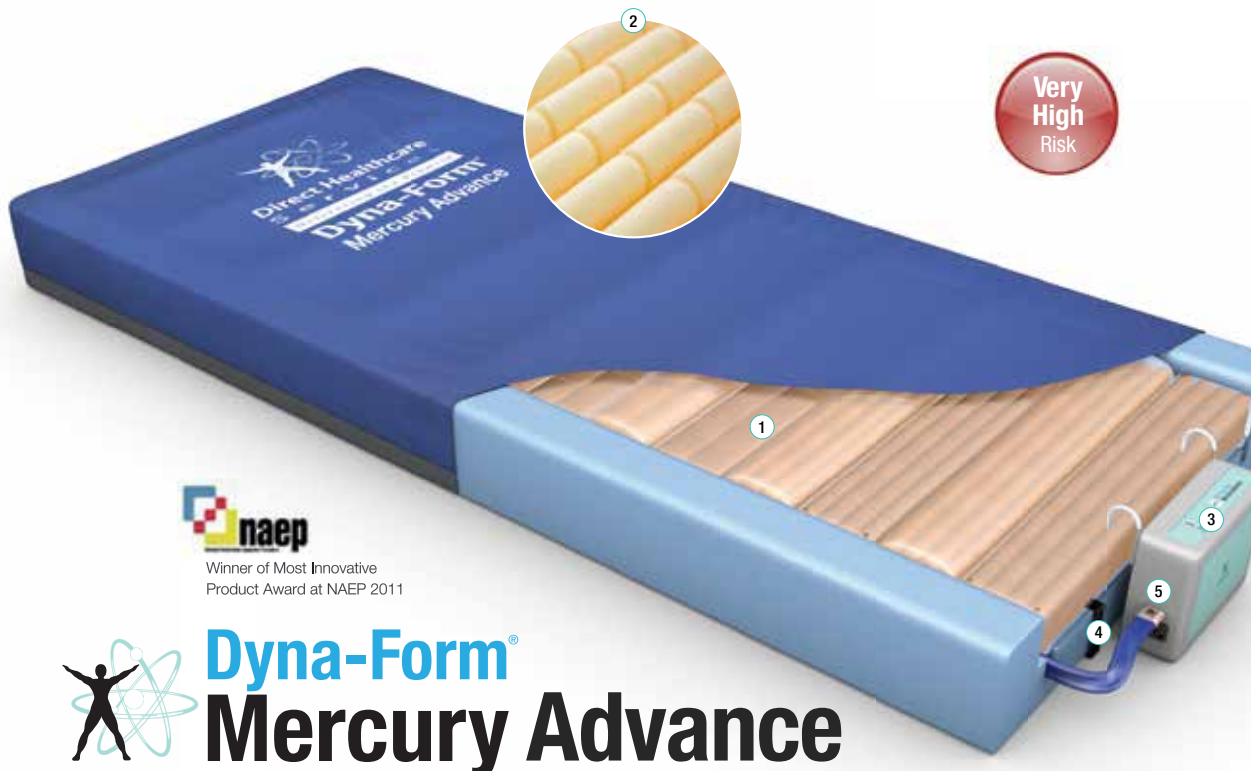

Winner of Most Innovative Product Award at NAEP 2011



Dyna-Form[®] Mercury Advance

MATTRESSES



Clinical Application / PU Grading

Technical Specifications

Product Code	MAT/MERADV/198/88/15
Risk Category	Very High Risk
Weight Limit	No minimum weight limit. Product evaluated to 40 stone / 254kg capacity
Warranty	2 Years
Dimensions	Standard Size (Length) 198cm x (Width) 88cm x (Height) 15cm
Product Weight	13.3kg mattress / 1.7kg Power Unit
Cycle Time	10 minutes
Mode of Operation	Electronic
Voltage	220V – 240V / 50HZ
Power Consumption	10W

Please note this product is also available with PU covered umbilical.

Infection Control / Hypochlorite Solution Compatible

Mattress Cover / Power Unit to be wiped down with Hypochlorite solution and warm water appropriately diluted.

The **Dyna-Form Mercury Advance** is a dynamic mattress replacement system combined with the benefits of modern foam technology. It is specifically designed for patients considered to be at 'Very High Risk' of pressure ulcer development. Offering high levels of patient comfort, this unique system has the facility to "step up" to that of a dynamic mattress when clinically required. Similarly, the mattress's function can be downgraded as the patient's condition improves.

These features make it particularly beneficial for use within the patient's home or palliative care environment and help reduce logistic and decontamination costs. The clinical benefits of a single system are equally applicable to those of a modern hospital setting. A higher maximum weight capacity, up to 40 stone / 254kg, allows the product to meet the modern challenges of those heavier clients. All component parts are interchangeable and replaceable, maximising product life and reducing environmental impact. The outer cover comprising a high frequency welded, multi stretch and vapour permeable fabric satisfies the strictest infection control policies.

CLINACTIV™

CODE	DESCRIPTION
11005	ClinActiv™



Dyna-Form®
Static Air HZ

Dyna-Form® Static Air HZ – A New Generation of Static Support Surface, developed in conjunction with the Welsh Wound Innovation Centre.

Dyna-Form Static Air HZ is a mattress replacement system that combines the benefits of effective air displacement technology with the best of modern foams for a new standard of innovative pressure ulcer prevention and management. A new and unique 'air only' Intelligent Heel Zone and specially designed U-Core effectively offload pressure on the particularly vulnerable heel area. Dyna-Form Static Air HZ is specifically designed for patients considered to be at **'Very High Risk'** of pressure ulcer development.

With patient compliance enhanced through the high levels of comfort offered and requiring no powered pump the system is ideal in community and palliative care settings whilst the clinical benefits and ease of use make it equally suitable in the acute ward environment. Incorporating air and foam and air only cells in the unique low pressure heel zone, a patented valve system allows Reactive Airflow System (RAST™) technology to adjust to the patient's body weight and movement.

Dyna-Form Static Air HZ pressure maps 20% better than a high specification foam mattress and has a higher maximum weight capacity of up to 40 stone / 254kg. All component parts are interchangeable and replaceable, maximising product life, reducing dynamic mattress usage and offering a very cost effective solution to pressure care management. The outer Dartex™ vapour permeable, multi way stretch fabric cover incorporates high frequency welded seams and deep flap zip protection conforming to the strictest infection control policies.

Technical Specifications

Product Code	MAT/STAT/HZ/198/88/15
Risk Category	Very High Risk
Weight Limit	No minimum weight limit. Product evaluated to 40 stone / 254kg capacity
Warranty	5 Years
Dimensions	(Length) 198cm x (Width) 88cm x (Height) 15cm – Variable Sizes Available
Product Weight	10kg
Fire Retardancy	BS7177; 2008 (Crib 5 Composite)
Hypochlorite Solution Compatible	1,000 ppm diluted or 0.1% (or to be used in conjunction with local infection control guidelines)

Infection Control / Hypochlorite Solution Compatible

Mattress Cover to be wiped down with hypochlorite solution and warm water appropriately diluted.



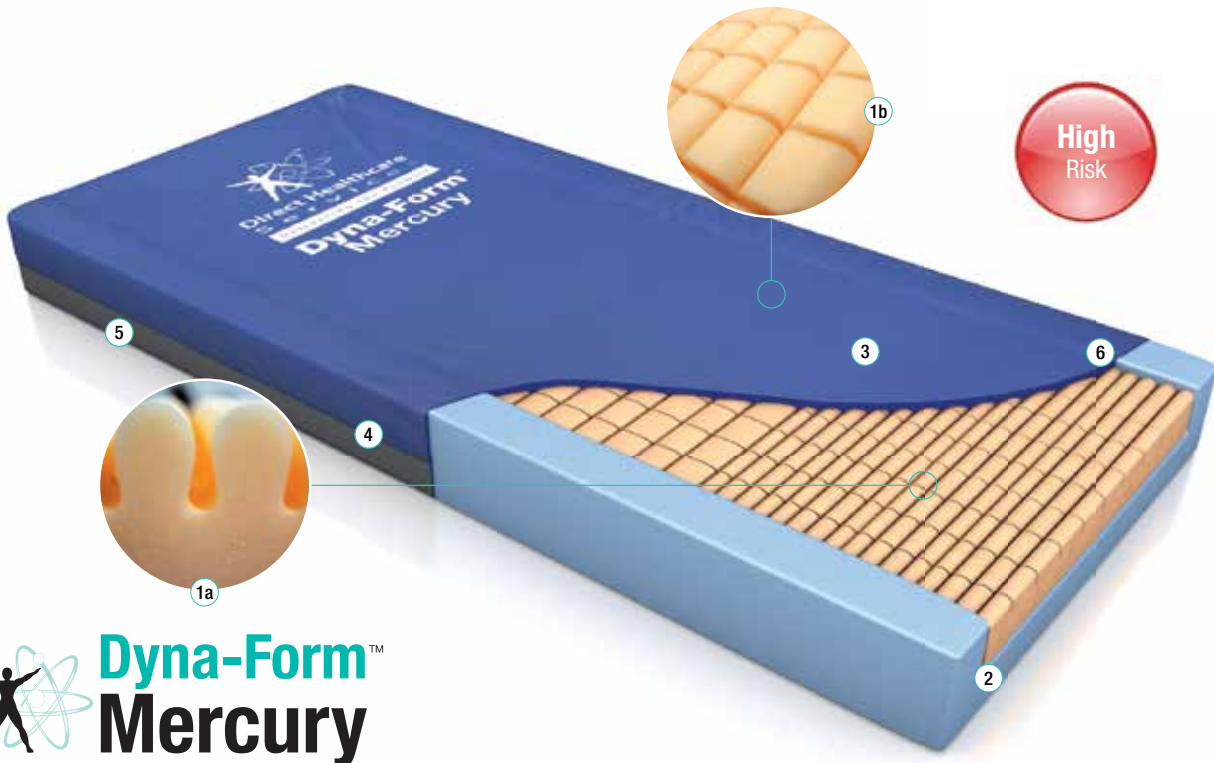

The **Dyna-Form Mercury** mattress is specifically designed for users considered to be at “**High Risk**” of pressure ulcer development. Comprising of a specialist “castellated cut” and blends of the finest quality Combustion Modified High Resilient foam (CMHR) this product provides not only the best pressure re-distribution properties, but great patient comfort & product longevity. Side Wall construction enables primary stability for patient transfer purposes. Complete with a durable, multi-stretch, vapour permeable cover and a toughened polyurethane base, the **Mercury** mattress provides an important contribution towards the infection control and tissue viability standards of a modern hospital, nursing or homecare environment.

Features

Benefits

1a	1b	Castellated foam insert (with tear duct cut)	1a smaller castellated cells for heels and larger cells sacrally
2		Finest quality CMHR foam base and side walls	Prevents patient bottoming out and aids patient transfer
3		Multi-stretch, vapour permeable fabric (impregnated with an anti fungal agent)	Reduces shear & friction forces, whilst assisting infection control policies
4		Fully high frequency welded cover	Prevents fluid ingress & aids decontamination processes (can be laundered up to 95°C)
5		Toughened PU / non-slip base	Provides a robust protective surface against hydrolysis / strikethrough
6		Fully replaceable parts	Ensures great value for money

Technical Specifications

Product Code	MAT/MER/198/88/15
Risk Category	High Risk
Weight Limit	40 Stone / 254kg
Warranty	8 Years Foam / 4 Years Cover
Dimensions	(Length) 198cm x (Width) 88cm x (Height) 15cm – However Variable Sizes Available Upon Request
Foam Density	Blue 38–40kg/m ³ Nominal Hardness – 200 Newtons Pink 38–40kg/m ³ Nominal Hardness – 120 Newtons
Fatigue Class	Very Severe
Fire Retardancy	BS7177; 2008 (Crib 5 Composite)
Weight	11kg
Hypochlorite Solution compatible	1,000 ppm diluted or 0.1% (or to be used in conjunction with local infection control guidelines)

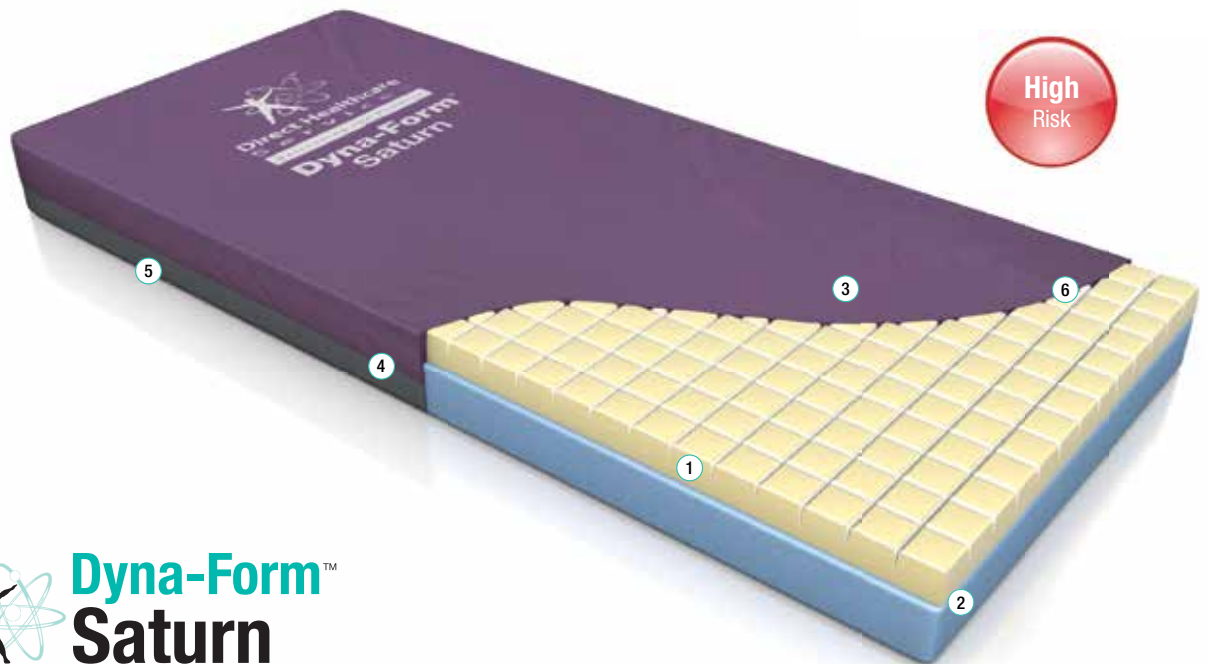

Dyna-Form™ Saturn

The **Dyna-Form Saturn** mattress is designed for users considered to be that of “**High Risk**” of pressure ulcer development and for patients requiring complete comfort, whilst maintaining the highest pressure care support from a static mattress. By using a blend of temperature sensitive, visco elastic foam at patient interface with the finest quality CMHR foam, the **Dyna-Form Saturn** provides excellent pressure re distribution properties, but with patient comfort foremost considered within its design. Longevity is enhanced by using a mixture of modern foam technology and a contemporary cover. **Saturn’s** durable, multi-stretch, vapour permeable cover also possesses a toughened polyurethane base for use on all bed frame designs.

Features

- ① Temperature sensitive visco elastic foam surface (castellated cut)
- ② Finest quality CMHR foam base
- ③ Multi-stretch, vapour permeable fabric (impregnated with an anti fungal agent)
- ④ Fully high frequency welded cover
- ⑤ Toughened PU / non-slip base
- ⑥ Fully replaceable parts

Benefits

- Provides excellent patient comfort by conforming to the body contours
- Prevents patient bottoming out and enhances longevity
- Reduces shear & friction forces, whilst assisting infection control policies
- Prevents fluid ingress & aids decontamination processes (can be laundered up to 95 °C)
- Provides a robust protective surface against hydrolysis / strikethrough
- Ensures great value for money

Technical Specifications

Product Code	MAT/SAT/198/88/15
Risk Category	High Risk
Weight Limit	40 Stone / 254kg
Warranty	8 Years Foam / 4 Years Cover
Dimensions	(Length) 198cm x (Width) 88cm x (Height) 15cm – However Variable Sizes Available Upon Request
Foam Density	Visco elastic foam – 55–60kg/m ³ Nominal Hardness – Soft to Medium Blue CMHR Foam – 38–40kg/m ³ Nominal Hardness – 200 Newtons
Fatigue Class	Very Severe
Fire Retardancy	BS7177; 2008 (Crib 5 Composite)
Weight	16kg
Hypochlorite Solution compatible	1,000 ppm diluted or 0.1% (or to be used in conjunction with local infection control guidelines)

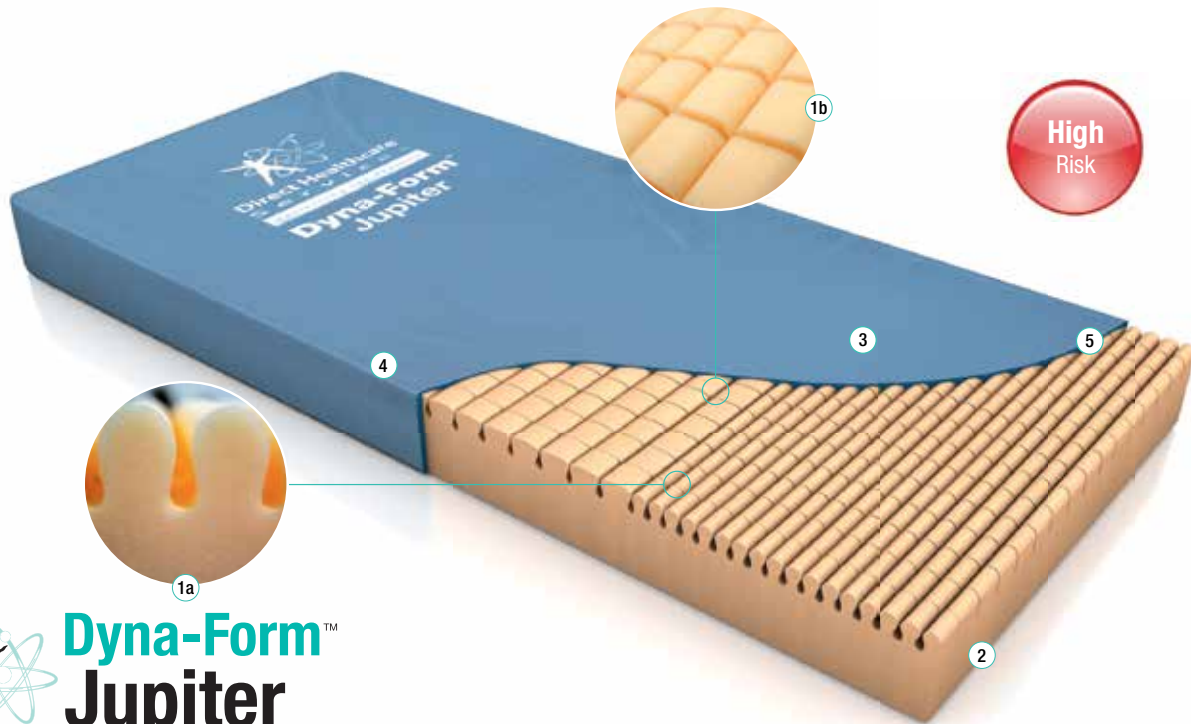

The **Dyna-Form Jupiter** mattress can be used with patients considered to be up to that of “**High Risk**” of pressure ulcer development. Using modern foam designs, castellated on one side to aid pressure ulcer management, whilst providing excellent patient comfort; this mattress can be used without a turning programme, aiding moving & handling procedures. **Jupiter** can work comfortably with any electric profiling bed frame. Its durable design uses only the very best CMHR foam & fabrics to provide a modern mattress complete with infection control enhancing cover.

Features

- 1a 1b Castellated foam (with tear duct cut)
- 2 Single sided cut surface
- 3 Multi-stretch, vapour permeable fabric (impregnated with an anti fungal agent)
- 4 Fully sewn or high frequency welded cover. (NB: welded cover option carries a small price premium)
- 5 Fully replaceable parts

Benefits

- 1a smaller castellated cells for heels and 1b larger cells sacrally
- Works without a turning programme
- Reduces shear & friction forces, whilst assisting infection control policies
- Prevents fluid ingress & aids decontamination processes (can be laundered up to 95°C)
- Ensures great value for money

Technical Specifications

Product Code	MAT/JUP/198/88/15
Risk Category	High Risk
Weight Limit	26 Stone / 165kg
Warranty	3 Years
Dimensions	(Length) 198cm x (Width) 88cm x (Height) 15cm – However Variable Sizes Available Upon Request
Foam Density	34–36kg/m ³ Nominal Hardness – 125 Newtons
Fatigue Class	Very Severe
Fire Retardancy	BS7177; 2008 (Crib 5 Composite)
Weight	10kg
Hypochlorite Solution compatible	1,000 ppm diluted or 0.1% (or to be used in conjunction with local infection control guidelines)





MIDMARK SPECIALTY TREATMENT CHAIRS



MIDMARK/RITTER/PROMOTAL TREATMENT, EXAMINATION COUCHES AND PATIENT STRETCHERS

Midmark/Ritter/Promotal treatment and examination couches specifically designed for the clinical requirements of:

- Obstetrics and Gynaecology
- Paediatrics
- Podiatry
- ENT
- Eye surgery
- Dermatology
- Phelbotomy
- Plastic and maxio facial
- Transfer stretchers
- Bariatric options available
- Procedure Stools

Available in electric or fixed height and with multiple accessories such as:

- Heated draw pans
- Hideaway stirrups
- Knee crutches
- Arm systems

Also available:

- Bariatric treatment couches designed for patients up to 385kg
- A wide range of treatment stools

FOR MORE INFORMATION CONTACT:
USL MEDICAL CUSTOMER SERVICES ON 0800 658 814



Because we care.

REUSABLE TEXTILES

- BED PADS & CHAIR PADS
- CLOTHING PROTECTORS & PATIENT GOWNS
- LAUNDRY BAGS & CARTS
- SHEETS & BEDSPREADS
- SLIDE SHEETS



MIP CHAIRPADS

- Quality surface fabric adds comfort to virtually any seating surface
- Absorbent soaker provides effective fluid containment, ensuring discreet wetness protection for the seated resident
- Impermeable barrier shields seat surfaces from fluid damage

MIP CHAIRPADS

CODE	DESCRIPTION	MEASUREMENT
90040	MIP Chairpad - Blue Velour	53cm x 58cm
90041	MIP Chairpad - Brown Velour	53cm x 58cm
90043	MIP Chairpad - Green Velour	53cm x 58cm
90044	MIP Chairpad - Maroon Velour	53cm x 58cm



MIP BEDPAD- CHAMONIX

- Long-term protection and durability
- Soft, Stay Dry surface is made up specially constructed fibers that channel fluid down into the absorbent soaker, allowing for surface dryness and comfort in just minutes. Resilient, stain resistant fabric withstands the effects of multiple washings, increasing its value.

MIP BEDPADS - 2.4L FLAPS

CODE	DESCRIPTION	MEASUREMENT
8861	MIP Bed Pad 2.4L Flaps	85 x 90cm

MIP BEDPAD - DERMACARE

Designed to compliment Body Worn Inco Systems.



- Stay-Dry - will keep patient dry.
- Absorbency - 1500ml and will retain its stay-dry benefits.
- Softness - great comfort is of importance for people who spend most of their days lying in bed.
- Thin - Adds to the comfort of the patient by eliminating bulk under the individual.
- Brushed barrier will keep the pad in place.
- Ultra light weight , 460 grams, reducing washing and drying time.



MIP BEDPAD - MERIDIAN

- Highly effective continence care protection
- Sheared stay dry surface is soft on skin and keeps patients/residents dry, comfortable and well-rested
- Absorbant polyester/rayon soaker helps wick moisture away from the skin
- Quality construction withstands numerous laundering providing long-term use and value

MIP BEDPADS - DERMACARE

CODE	DESCRIPTION	MEASUREMENT
90481	MIP Bed Pad - Dercare	85 x 90cm

MIP BEDPADS

CODE	DESCRIPTION	MEASUREMENT
90026	MIP Bedpad Meridian 1.5L	86cm x 91cm



MIP QUILTED BEDPAD

- Three layers of protection and comfort
- Soft, quality, cotton/polyester surface provides comfort and keeps patients/residents dry
- Absorbent polyester/rayon soaker ensures effective fluid containment
- Impermeable barrier shields bed linens from fluid damage, avoiding numerous changes
- Durable construction withstands industrial machine washing and drying
- 1200ml Absorbency

SONOMA BEDPADS

Reliable, Economical Wetness Protection

- Stay Dry, stain-resistant surface keeps patients dry and comfortable promoting good skin care
- Absorbent polyester/rayon soaker and impermeable barrier provide effective fluid-proof protection
- Resilient fabric withstands multiple washes without sacrificing quality, comfort or performance
- 1500ml Absorbency

MIP BEDPADS - VALUE		
CODE	DESCRIPTION	MEASUREMENT
90027	MIP Bedpad Quilted	85cm x 130cm
90031	Bedpad drawsheet replacement	85cm x 90cm
90030	Bedpad with tuckins, drawsheet replacement	85cm x 90cm

MIP BEDPADS - SONOMA		
CODE	DESCRIPTION	MEASUREMENT
90029	MIP Bedpad - Sonoma Long 2L	86cm x 115cm
90028	MIP Bedpad Sonoma 1.5L Flaps	86cm x 91cm



COLOURS



CLOTHING PROTECTOR - NAPKIN STYLE

Providing dignity to residents these specially designed quick drying napkin style dignified adult aprons, help to reduce processing costs. Made from highly durable polyester ivy leaf fabrics in order to give the best possible life span. Complete with fluid proof backing fabric to optimise protection, and snap closure.

MIP CLOTHING PROTECTOR

CODE	DESCRIPTION
12751	Clothing Protector - 46 cm x 46 cm - Green
12750	Clothing Protector - 46 cm x 46 cm - Ivory
12749	Clothing Protector 46 cm x 46 cm - Maroon



AURORRA

- Absorbent surface fabric offers a dignified appearance and effective liquid protection
- Highly durable, quick-drying material ensures minimal shrinkage and resists pilling, reducing replacement costs
- Adjustable, stainless steel snap closures at back of neck keep clothing protector securely in place

MIP CLOTHING PROTECTOR

CODE	DESCRIPTION
90146	Clothing Protector - Blue - 45 x 90 cm
90147	Clothing Protector - Blue stuart - 45 x 90 cm
90148	Clothing Protector - Gingham - 45 x 90 cm



PERMA PRINT

- Absorbent, colourfast surface and liquid-proof barrier keep clothes dry effectively protecting against light spills
- Generous sizing provides maximum coverage to the chest and lap
- Adjustable, stainless steel snap closures at back of neck keep clothing protector securely in place

MIP CLOTHING PROTECTOR

CODE	DESCRIPTION
90064	Clothing Protector - Blue stuart - 45 x 90 cm
90065	Clothing Protector - Gingham - 45 x 90 cm



MIP PATIENT GOWN

Blue Modessa Gown with Snowflake print

Back Length	44"
Full Sweep	66"
Sleeve Length	19"

PATIENT GOWN

CODE	DESCRIPTION
90125	MIP Patient Gown

LAUNDRY CARTS

Laundry handling made easy

Features:

- Rust-proof stainless steel frame provides long-term durability
- 1, 2, 3, or 4 bag configurations are available to meet your specific requirements
- Snug-fitting lids control odours
- Unique fitting ring holds bags securely in place
- Quality, full-swivel wheels allow for ease of mobility
- Limited lifetime warranty
- Foot pedal option



LAUNDRY CARTS

CODE	DESCRIPTION
90050	1 Bag Cart (48cm wide x 38cm long x 94cm high)
90051	2 Bag Cart (48cm wide x 66cm long x 94cm high)
90052	3 Bag Cart (48cm wide x 99cm long x 94cm high)
90128	Foot Pedal 1 per Lid

STANDARD LAUNDRY BAG

Containment Starts Here

Features:

- Impermeable barrier and sealed seams eliminate leakage, retain odours and protect staff from contamination
- Draw cord with closure keeps contents secure
- Standard and tapered bag styles feature a colour-coded topper
- Available in a wide range of colours
- 70cm x 97cm



STANDARD LAUNDRY BAGS

CODE	DESCRIPTION	MEASUREMENTS
90099	Laundry Bag - Blue	70cm x 97cm
90100	Laundry Bag - Green	70cm x 97cm
90105	Laundry Bag - Orange	70cm x 97cm
90101	Laundry Bag - Red	70cm x 97cm
90103	Laundry Bag - White	70cm x 97cm
90106	Laundry Bag - Yellow	70cm x 97cm
11305	Laundry Bag - Brown	70cm x 97cm
11161	Laundry Bag - Purple	70cm x 97cm

IMPERMEABLE LAUNDRY BAGS

Containment Starts Here

Features:

- Keeps infected linens secure, and when in washing machine seams dissolve releasing the contents into the washload
- Draw cord with closure keeps contents secure
- Standard and tapered bag styles feature a colour-coded topper
- Available in blue, green, red, yellow and white



IMPERMEABLE LAUNDRY BAGS

CODE	DESCRIPTION	MEASUREMENTS
90048	Laundry Bag - Red	70cm x 97cm
90046	Laundry Bag - Blue	70 x 97cm
90047	Laundry Bag - Green	70cm x 97cm
90049	Laundry Bag - Yellow	70cm x 97cm
90901	Laundry Bag - White	70cm x 97cm



MIP SLEEPKNIT BOTTOM SHEET

Sleepknit bottom fitted sheet

- Smooth, plated, cotton/polyester linen provides maximum patient comfort and great convenience for caregivers
- Four-way stretch construction offers a wrinkle-free surface and reduces shearing and friction, minimizing bedsores
- Patented knitted fitted envelope design allows for a secure fit and saves bedmaking time and effort

MIP BOTTOM SHEET

CODE	DESCRIPTION	COLOUR
80016	MIP Sleepknit Bottom Sheet	Yellow Fitted
80017	MIP Sleepknit Bottom Sheet	Peach Fitted
80018	MIP Sleepknit Bottom Sheet	White Fitted
90073	MIP SleepKnit Bottom Sheet	Blue Fitted
90077	MIP Sleepknit Bottom Sheet	Green Fitted



MIP TOP SHEET

Patient comfort and staff convenience

- Quality, soft, cotton/polyester blend promotes patient comfort and product durability
- Unique semi-contour design facilitates bed making and ensures that semi-fitted sheets remain tucked in
- Patented Foot-Ease feature offers additional foot room and relieves pressure off feet
- Elastic-free construction allows for additional durability

MIP TOP SHEET

CODE	DESCRIPTION	COLOUR
13160	MIP Sleepknit Top Sheet	Peach Fitted
13167	MIP Sleepknit Top Sheet	Yellow Fitted
80019	MIP Sleepknit Top Sheet	White Fitted
90074	MIP SleepKnit Top Sheet	Blue Fitted
90075	MIP SleepKnit Top Sheet	Green Fitted

MIP STRETCHER SHEET



MIP STRETCHER SHEET

CODE	DESCRIPTION	MEASUREMENTS
91001	MIP Stretcher Sheet White	W56-71cm x L185-196cm
90078	MIP Stretcher Sheet Blue	W56-71cm x L185-196cm
80021	MIP Sleepknit Stretcher Sheet Blue	

FLAT SHEETS AND PILLOW CASES



FLAT SHEETS AND PILLOW CASES

CODE	DESCRIPTION	
90021	MIP Percale bed sheet, white, 55/45 cotton poly,	168cm x 275cm
90022	MIP Percale pillow case, white, 55/45 cotton poly	53cm x 78cm



MIP THERMAL BLANKET

Sleepknit bottom fitted sheet

- Smooth, plated, cotton/polyester linen provides maximum patient comfort and great convenience for caregivers
- Four-way stretch construction offers a wrinkle-free surface and reduces shearing and friction, minimizing bedsores
- Patented knitted fitted envelope design allows for a secure fit and saves bedmaking time and effort
- Available in Blue, Cream, Green, Lilac & White

MIP THERMAL BLANKET

CODE	DESCRIPTION	
90020	MIP Blanket	50/50 Thermal weave
90032	MIP Blanket - Thermal - Blue	224 x 178 cm
90033	MIP Blanket - Thermal - Cream	224 x 178 cm
90034	MIP Blanket - Thermal - Green	224 x 178 cm
11528	MIP Blanket - Thermal - Lilac	224 x 178cm
90123	MIP Blanket - Thermal - White	224 x 178cm

BATH TOWELS, HAND TOWELS & FACE CLOTHS

- Our Euro Towel Range is made from 100% cotton and is a medium pile towel with no bands.
- As it is a lighter weight towel, the Euro range dries quickly, so is ideal for in-house laundering
- Also available in colours: Buttermilk, Sage, Chocolate and Navy

BATH TOWELS, HAND TOWELS & FACE CLOTHS		
CODE	DESCRIPTION	MEASUREMENTS
13985	Euro Bath Towel, white, 489gms	70cm x 137cm
141232	Euro Face Cloth, white, 56gms	33cm x 33cm
141231	Euro Hand Towel, white, 138gms	41cm x 66cm



HELP TO REDUCE SKIN TEARS BY USING SLIDESHEETS

- Slide sheets help reduce shear and friction when moving residents on beds.
- Training is required as incorrect application can cause injury to both carers and residents.

SLIDE SHEETS ARE USED FOR:

- Moving residents in bed
- Turning residents on to their side in bed
- Transferring residents from a bed to a bed with a transfer board
- For residents who has fallen into a confined space; slide sheets can be used to move the residents along the floor to a location where a hoist can be used
- Facilitating independent bed mobility.

SLIDE SHEETS

CODE	DESCRIPTION	MEASUREMENT
90104H	Slide Sheet Purple	1.5 x 2m Hemmed
9548	Slide Sheet Teal	1.0 x 1.5m Hemmed

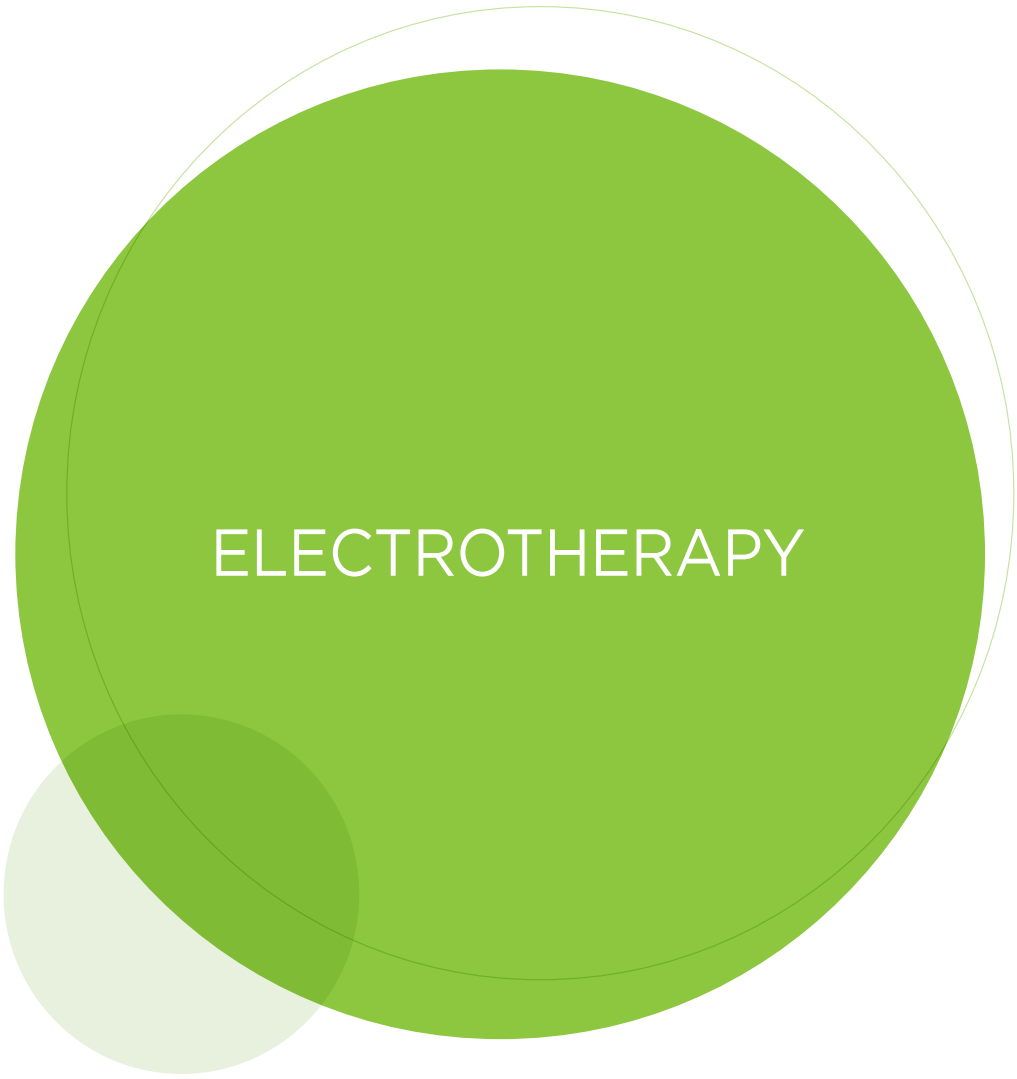

ELECTROTHERAPY



INTELECT® MOBILE ULTRASOUND

- 1 and 3MHz frequencies
- Pulsed and continuous therapy operation (10%, 20%, 50% and 100%)
- Variable duty cycle outputs of 16Hz, 48Hz, or 100Hz
- Clinical protocols, the most appropriate application and parameter set for the patient's condition
- 10 user-defined memory positions
- Beam non-uniformity ratio (BNR) 6:1 maximum
- Lightweight design, along with battery-powered option
- Unit uniquely designed for tabletop, wall mount, or mobile use
- Ergonomically designed soundheads in variety of sizes (1cm², 2cm², 5cm² and 10cm²)
- All sound heads are interchangeable due to Electronic Signature™ residing on all transducers
- Head warming feature and head contact control with visual and auditory feedback on all sound heads
- 3 year warranty (accessories 1 year)

Standard Accessories

- 5cm² Applicator
- Ultrasound Gel
- User Manual on CD



INTELECT® MOBILE INTERFERENTIAL

- 2 channels of stimulation output
- Independent intensity and parameter controls for each channel
- Multiple waveforms on board: (2 Pole IFC, 4 Pole IFC, Galvanic, High Voltage Pulsed Current (HVPC), Microcurrent, Russian, Träbert, Monophasic Triangular, Monophasic Rectangular, Diadynamic, VMS and TENS)
- 15 user-defined memory positions
- Lightweight design, along with battery-powered option
- Unit uniquely designed for tabletop, wall mount, or mobile use
- 3 year warranty (accessories 1 year)

Standard Accessories

- Nylatex® Wrap.
- 6 x 8 cm carbon electrodes (x4)
- 6 x 8 cm sponges (x4)
- User Manual on CD



INTELECT® MOBILE ULTRASOUND

CODE	DESCRIPTION	UNIT
8558	Intellect® Mobile Ultrasound 1 and 3MHz	each

INTELECT® MOBILE INTERFERENTIAL

CODE	DESCRIPTION	UNIT
8560	Intellect® Mobile Interferential 2 Channels	each



INTELECT® MOBILE COMBINATION UNIT

- 1 and 3 MHz ultrasound frequencies
- Pulsed and continuous ultrasound therapy operation (10%, 20%, 50% and 100%)
- Variable duty cycle outputs of 16Hz, 48Hz, or 100Hz for ultrasound
- Multiple waveforms on board: (2 Pole IFC, 4 Pole IFC, Galvanic, High Voltage Pulsed Current (HVPC), Microcurrent, Russian, Träbert, Monophasic Triangular, Monophasic Rectangular, Diadynamic, VMS and TENS)
- 15 user-defined memory positions
- Lightweight design, along with battery powered option
- Unit uniquely designed for tabletop, wall mount or mobile use
- Ergonomically designed soundheads for ultrasound therapy in variety of sizes (1cm², 2cm², 5cm² and 10cm²)
- All sound heads are interchangeable due to Electronic Signature™ residing
- 3 year warranty (accessories 1 year)



*Therapy cart sold separately

INTELECT® MOBILE COMBINATION UNIT		
CODE	DESCRIPTION	UNIT
8561	Intellect® Mobile Combination Unit	each



INTELECT® ADVANCED COMBO THERAPYSYSTEM

Clinically convenient, the Intellect® Advanced Therapy System provides all the necessary tools in one package to maintain efficiency in the clinic and improve patient care.

- More than 25 clinical waveforms
- 2 independent Electrotherapy channels
- sEMG and sEMG + electrical stimulation standard
- High resolution colour display of all screens
- Over 200 clinical protocols
- Over 100 user-defined protocol slots
- Over 10 quick-link indications for quick parameter retrieval
- Impressive clinical library which includes full colour graphic anatomical and pathological libraries on vibrant LCD screen
- Documentation of treatment outcomes with patient data cards
- Sequencing to direct a designated therapeutic course without having to modify the unit
- 1 and 3Mhz ultrasound frequencies
- Pulsed and continuous modes (10%, 20%, 50% and 100%)
- Variable duty cycles (16Hz, 48Hz and 100 Hz)
- BNR 5:1 maximum
- Ergonomically designed sound heads in 1cm², 2cm², 5cm² and 10cm²
- 3 year warranty (accessories 1 year)

*Therapy cart sold separately

INTELECT® ADVANCED COMBO THERAPY SYSTEM		
CODE	DESCRIPTION	UNIT
9169	Intellect® Advanced Combo Therapy System	each



INTELECT® MOBILE BATTERY PACK

Electrotherapy on the go. A self-contained nickel metal hydride battery that stores conveniently in the bottom of the Intelect® Mobile Ultrasound, Stimulation, Combination, or Laser Unit.

INTELECT® MOBILE BATTERY PACK		
CODE	DESCRIPTION	UNIT
7113	Intelect® Mobile Battery Pack	each



INTELECT® ULTRASOUND APPLICATORS

Pre-calibrated, waterproof and ergonomically designed sound heads which operate at 1 and 3Mhz frequencies. The applicators are equipped with coupling indicators and are interchangeable between all Intelect® Mobile Units.

INTELECT® ULTRASOUND APPLICATORS		
CODE	DESCRIPTION	SIZE
9725	Intelect® Ultrasound Applicators	1cm
904781	Intelect® Ultrasound Applicators	2cm
9723	Intelect® Ultrasound Applicators	5cm



INTELECT® THERAPY CART SYSTEM

Designed with functionality in mind, the cart provides from 4 to 6 bins for storage (depending upon whether or not vacuum option is added). The cart integrates with the main unit to minimise cord and cable hassles. (Unit not included).

INTELECT® THERAPY CART SYSTEM		
CODE	DESCRIPTION	UNIT
8559	Intelect® Therapy Cart System	each



INTELECT® MOBILE CART ADAPTER

The mobile adapter allows the range of Intelect® Mobile Units to connect to the Intelect® Therapy Cart and Interferential suction unit.

*Indent Item

INTELECT® MOBILE CART ADAPTER		
CODE	DESCRIPTION	UNIT
2883*	Intelect® Mobile Cart Adapter	each



INTELECT® TENS STANDARD PORTABLE STIMULATOR

For symptomatic relief and management of chronic pain and acute post-surgical or post-trauma pain.

- Dual, independent channels
- Adjustable parameters
- 3 stimulation modes (burst, normal, modulation)
- Flip cover to protect top controls

INTELECT® TENS STANDARD PORTABLE STIMULATOR		
CODE	DESCRIPTION	UNIT
6948	Intellect® Tens Standard	each



INTELECT® NMES DIGITAL AND PORTABLE STIMULATOR

For the prevention of disuse atrophy as well as muscle re-education, increasing range of motion and increasing circulation.

- Neuromuscular electrical stimulation
- Dual, independent channels
- Adjustable parameters
- 3 stimulation modes (synchronous, constant, alternate)
- Patient compliance timer
- LCD display on digital model

INTELECT® NMES DIGITAL PORTABLE STIMULATOR		
CODE	DESCRIPTION	UNIT
9321	Intellect® NMES Digital Stimulator	each
10332	Intellect® NMES Portable Stimulator	each



HYDROCOLLATOR® E-1 STATIONARY HEATING UNIT

The benchmark against which all other heating units are judged.

- Thermostatically controlled temperature
- Dimensions (H x L x W) 41 x 33 x 20cm
- Includes 4 standard size HotPacs
- Main power - 110-240v 50/60Hz
- No plumbing required
- High quality stainless steel
- Weight - 7kg
- Tank capacity - 15 litres

HYDROCOLLATOR® E-1 STATIONARY HEATING UNIT		
CODE	DESCRIPTION	SIZE
3957	Hydrocollator® Heating Unit	15 litre



SONICLEAN HEAT PAN

The Soniclean Heat Pan is specifically designed as a water heater for the activation of thermoplastic materials. It comes complete with a temperature control and digital display.

SONICLEAN HEAT PAN	
CODE	DESCRIPTION
9584	Soniclean Heat Pan



VEINOPLUS SPORT®

Created in 2004 by Paris-based Ad Rem Technology, VEINOPLUS® device family has opened new horizons for the use of electro-stimulation in MEDICAL, SPORTS and WELL-BEING fields thanks to its innovative “Second Heart” technology. After 3 years of R & D and in co-operation with the top athletes, Ad Rem Technology launched for London Olympic Games a decisive innovation in sport recovery: VEINOPLUS® SPORT.

3 Effects

- Accelerated lactate clearance
- Local analgesic effect
- Relaxing action

2 Recoveries

- Whole body recovery: activates the Second Heart® (ie the calf-pump)
- Local recovery: relieves pain, prevents cramps and muscle soreness

1 Program

- Signal optimized for sport recovery
- Takes only a few minutes to be efficient

VEINOPLUS® SPORT

CODE	DESCRIPTION	SIZE
16003	Veinoplus Sport EMS Device	Each
16000	Veinoplus Device Electrodes	Each
16005	Veinoplus Sport Power Cuffs	Pair



VEINOPLUS BACK®

The Veinoplus Back offers a unique program of pain relief and a relaxing massage which acts on the three main areas of the back. Compact and easy to use, you can take it anywhere. The signals of stimulation are a combination of TENS and NMES. TENS (Transcutaneous Electrical Nerve Stimulation) is widely recognised to alleviate pain whereas NMES (Neuro-muscular Electrical Stimulation) stimulates the muscles to cause their contractions and inturn relieve (relax) muscle spasms. Veinoplus® Back combines 4 effects providing back pain relief in one single stimulation program.

- Soothes back pain
- Delivers a relaxing massage
- Relieves muscle spasms
- Release natural endorphins to relieve general pain

VEINOPLUS® BACK		
CODE	DESCRIPTION	SIZE
16001	Veinoplus Back EMS Device	Each
16000	Veinoplus Device Electrodes	Pair



WEINMANN EMERGENCY

- VENTILATION
- DEFIBRILLATION & MONITORING
- SUCTION



MEDUMAT EASY

Ventilator with voice prompts

MEDUMAT Easy is extremely safe and easy to use. Trained first aid staff and First Responders quickly understand how to use the ventilator and can concentrate completely on the patient. Spoken instructions support the rescue worker at every step. The demand-flow mode in oxygen inhalation manages the delivery of oxygen and adjusts to the needs of the patient.

User-friendly

- Safe and easy to use
- Clear and concise voice prompts lead to safe ventilation
- User guidance available in several different languages
- Acoustic alarms and visual error messages
- Display for ventilation monitoring

Ergonomic

- Small and light
- EN-1789-conformance for wall-mounted holder and carrying platforms can be stowed on Weinmann carrying platforms and in Weinmann emergency backpacks

Energy supply / Oxygen usage

- Maintenance-free lithium batteries with a service life of at least two years (no charging required)
- No internal usage of oxygen
- Optimised oxygen usage with demand-flow mode: The patient receives oxygen during inspiration; no oxygen loss during exhalation as caused by continuous flow
- Ventilation or inhalation
- Controlled ventilation (IPPV) can be set by simply turning the rotary dial (time-cycled, volume-constant)
- PEEP valve can be connected



MEDUMAT EASY CPR

Voice-guided ventilator optimized for Cardiopulmonary Resuscitation

MEDUMAT Easy CPR is extremely safe and easy to use. The voice-guided device assists trained First Responders and Emergency Medical Technicians with emergency ventilation and Cardiopulmonary Resuscitation (CPR). When you are carrying out life-saving measures, MEDUMAT Easy CPR operating in CPR mode supplies you with unmistakable spoken instructions and gives you the right timing of chest compressions with the help of its metronome. The ventilator also lets you manually generate a ventilated breath by activating MEDUtrigger on the mask. With the timing of the ventilated breath under your control, MEDUMAT Easy CPR can be integrated perfectly in the CPR process.

Top features of MEDUMAT Easy CPR:

- Voice prompts and metronome function for support of Cardiopulmonary Resuscitation
- Spoken instructions help with detection and resolution of problems
- Simple and safe selection of settings for controlled ventilation:
- Visual and acoustic alarms (LED, alarm signals and voice prompts)
- Illuminated ventilation pressure display is ideal for use in the dark
- Small and light and therefore suitable for use at scene of emergency

CODE	DESCRIPTION
12581	WM MEDUMAT Easy Vent Device

CODE	DESCRIPTION
WM28140	WM MEDUMAT Easy CPR



MEDUMAT STANDARD 2

A clear new perspective

Every second counts in an emergency. Especially when the patient needs respiratory support, a quick reaction can save lives. A completely new look at state-of-the-art ventilation comes with MEDUMAT Standard², the advanced development of MEDUMAT Standard and MEDUMAT Standarda. Its most striking feature is a monitor with a large color display. All critical respiratory parameters are quickly and clearly shown on the screen. Highly organized operating elements and symbols and effective acoustic and visual alarms ensure the highest level of safety.

More functions for Emergency Medical Technicians

Compared to previous models, MEDUMAT Standard² has many more functions. Access to ventilation, for example, is gained by entering the patient's height. Modes include IPPV, CPR (for Cardiopulmonary Resuscitation), RSI (Rapid Sequence Intubation for support with induction of anesthesia, and CPAP (for non-invasive therapy).



MEDUMAT STANDARD A VENTILATOR

The Ventilation Standard A for Professionals

MEDUMAT Standard A offers you everything you need for reliable emergency ventilation. Users around the world are impressed by its especially simple operation and ruggedness. With controlled ventilation and assisted ventilation, we provide you with the ventilation options you require in an emergency. Our diverse modules let you add many supplemental functions, such as CPAP therapy, to MEDUMAT ventilators. When there's not a second to lose, the well-designed operating panel with special symbols and colors help you to quickly set the right ventilation parameters. When placed on our portable LIFE-BASE system, the MEDUMAT Standard A has practically unlimited mobility.

An advantage MEDUMAT Standard A has over manual ventilation is the option of setting constant values for tidal volume, ventilation frequency and minute volume. These settings help to prevent ventilator-induced injuries*. Furthermore, with a ventilator you can reliably prevent hyperventilation and damaging pressure peaks*. That reduces the intrathoracic pressure, which in turn improves venous reflow and cardiac output*. You can keep your hands free to provide additional care to the patient. If a problem arises,

CODE	DESCRIPTION
WM28710	MEDUMAT Standard 2

CODE	DESCRIPTION
12577	MEDUMAT Standard A ventilator



WM28400

WM28300



WM MEDUMAT TRANSPORT

MEDUMAT Transport provides primary and secondary care for emergency and intensive-care transport patients. The adjustable ventilation parameters guarantee sufficient ventilation, specifically adapted to each patient.

For the best possible ventilation, the user can select from among five pressure-regulated and three volume regulated ventilation modes on MEDUMAT Transport. A sensitive trigger and a flow adjustment increase patient comfort in controlled and assisted ventilation modes. The device makes it possible for the user to continue the clinical therapy which was initiated during transport.

Further support is supplied by ventilation monitoring, which, in keeping with our philosophy, must always be a component of the ventilator.

In addition to the expiratory volume measurement available in MEDUMAT Transport, the device may also be optionally equipped with an integrated capnograph ETCO2 measurement.

The MEDUMAT Transport functions and qualities include clarity, simple and convenient operation and intuitive user guidance. All of these things guarantee a device that delivers top-level results with maximum reliability. With the information on the following pages you'll be able to form your own opinion of the innovative functions and exceptional capabilities of MEDUMAT Transport.

MEDUMAT Transport is available on the emergency carrying platform LIFE-BASE 4 NG.



CODE	DESCRIPTION
WM28400	Wm Medumat Transport With CO2
WM28300	Wm Medumat Transport Without CO2





MEDUCORE EASY (AED)

The MEDUCORE Defibrillator is small, compact and offers the most extensive monitoring treatment features available on the market. Every Second Counts: Without early defibrillation the chances of survival shrinks by 10% per minute.

Key Features

- Traffic light principle - stop/go
- 2 year warranty
- 5 year battery life
- Device will self test daily
- Automatic voice control - increases and decreases with the noise level in the room
- 30 month electrode shelf life
- Can be used from 20kgs of bodyweight on the standard electrodes without necessity of special paediatric electrodes
- Info-key calls up elapsed time and number of shocks since start
- Metronome function ensures correct chest compressions rate and ideal ratio of compression to ventilation
- Training devices are available
- Comes with scissors, mouth guard and razor
- Wall and vehicle mounts available
- Carry bag available
- Made in Germany
- Service for Meducore Easy can be carried out in Auckland, Taranaki and Christchurch

CODE	DESCRIPTION
12253	Meducore Easy 4005
12355	Wall Sign
12255	Wall Mount
12044	Protective Bag
WM 75885	AED Sticker



MEDUCORE STANDARD

Defibrillation, Monitoring and Ventilation MEDUCORE Standard is your strong partner for resuscitation.

The defibrillator supports paramedics with automatic analysis of cardiac rhythm, understandable voice prompts and a metronome for chest compressions so you can keep an eye on everything.

The perfect partner for everyday demands in emergency Medical care

The charging is done while MEDUCORE Standard is analysing the heart rhythm. The simultaneous operations reduce hands-off patient time to a minimum.

Trained users can choose to trigger defibrillation manually and do without the automatic heart rhythm analysis. The simple menu navigation and the professional alarm system ensure reliable monitoring and patient care. The long rechargeable battery life and the compact and rugged construction of MEDUCORE Standard also contribute to providing the best possible emergency medical care.

The large color display of ECG and other important parameters of heart rate, pulse and oxygenation keep the user informed at all times. All these features and functions make MEDUCORE Standard the perfect partner in the care of emergency patients under the toughest conditions



CODE	DESCRIPTION
WM 45005	MEDUCORE Standard Basic
WM 45000	MEDUCORE Standard Advanced
WM 45200	MEDUCORE Standard Professional



CORPULS 1

Small, handy and multifunctional

The new corpuls1 is a life-saving defibrillator/patient monitor that has been specifically developed to meet the requirements of fire fighters, first responders, patient transports and emergency management. The intuitive and easy operation of the corpuls1 allows immediate and comprehensive monitoring and therapy of the patient.

The functional protective bags for accessories as well as the brackets guarantee the safe and ergonomic transport of the corpuls1 to the emergency site.

- Compact and weighing only 2.2 kg
- Large 5.7" screen for ergonomic display of curves and parameters
- 6-lead ECG for optimised monitoring of the patient
- Non-invasive SpCO-, SpMetand SpHb measurement with Masimo® Rainbow™ SET
- Pre-connected electrodes for immediate use
- Compatible with corpuls3

**FOR MORE INFORMATION CONTACT:
USL MEDICAL CUSTOMER SERVICES ON 0800 658 814**





CORPULS 3

Patient Monitoring and defibrillator

The corpuls3 offers an entirely new and revolutionary design concept compared with traditional compact defibrillator/monitoring devices. It is designed as a complete modular system and can be split into:

- Monitoring unit
- Patient box
- Defibrillator/Pacer unit

Monitoring unit

The detachable Monitoring unit guarantees easy handling and provides a sophisticated solution at all times.

- Jog-dial, softkeys and function keys for intuitive, fast and immediate access and operation
- Large colour display (8,4") with individually configurable display views and 12 lead diagnostic ECG preview
- Integrated LAN or GSM for data transmission with corpuls.web

Patient box

The Patient box is the "heart" of the system and enables uninterrupted monitoring from the EMS site into the hospital.

- The immediate feedback on depth and rate of Thorax compressions of corPatch CPR ensures high quality CPR and improves the outcome of patients
- Simultaneous 12 lead diagnostic ECG with optional measuring and interpretation software
- Innovative Masimo® Rainbow® SET technology for measurement of SpO2, SpCO, SpMet, SpHb, PI and PP

Defibrillator/Pacer unit

Greater mobility and flexibility due to weight reduction if the defibrillator is not needed.

- Enhanced therapy options with

smartMetronome during CPR

- Pacing: fix, demand and overdrive pacing with ramp-down mode
- corPatch therapy master cable enables usage either with shock paddles, corPatch therapy electrodes or shock spoons

CORPULS CAN COME WITH MULTIPLE CONFIGURATIONS THE FOLLOWING ARE SOME OF THE OPTIONS:

- PACER
- AED - AND MANUAL MODE
- CORPATCH CPR
- 12 LEAD ECG
- SP02
- NIBP
- CO2
- IBP
- TEMP
- PRINTER



MANUVAC

Manual Suction Pump

The manual suction pump MANUVAC has been proven in emergency use. MANUVAC is rugged, stable, maintenance-free and simple to operate by hand, foot or knee.

CODE	DESCRIPTION
12726	Manuvac



SUCTION EASY DISPOSAL SUCTION

Suction Easy is an Oral Suction Device used to effectively clear the oral pharynx, without question, one of the most critical of basic rescue skills. The suction Easy is a convenient easy and efficient suction device. The Suction Easy is stored in the zip lock bag which doubles as a bio-hazard bag with the removal of label, enabling easy disposal after use. Fluid capacity is greater than 1000 cc with a vacuum force of 100 mm Hg. It will perform the job required on all patients quickly and effectively while being very affordable.

CODE	DESCRIPTION
12731	Suction Easy Disposable Unit



ACCUVAC BASIC

Electric Suction Pump

ACCUVAC Basic can be adjusted for any suction situation, thanks to variable subpressure regulation. Besides the robust casing, the handy grip, the stable base and the frontal, integrated hose clip, ACCUVAC Basic also is equipped with an energy display for the rechargeable battery.

CODE	DESCRIPTION
WM10700	ACCUVAC Basic Disposable
WM10790	ACCUVAC Basic Reusable



ACCUVAC RESCUE

Electric Suction Pump

ACCUVAC Rescue offers pre-selected suction levels that can be set with the push of a button. Within seconds the desired subpressure is available. In addition to the robust casing, the handy grip, the stable base and frontally integrated hose clip, the suction pump is equipped with intelligent charging management.

CODE	DESCRIPTION
WM10812	ACCUVAC Rescue Disposable
WM10620	ACCUVAC Rescue Reusable





COMBI BAG

Thanks to the unique technology of COMBIBAG, the 2-in-1 resuscitator for adults and children, you always have the right equipment on hand. With a simple 180-degree turn of the COMBIBAG, you vary the volumes quickly and automatically adapt the tidal volume to the patient.

The safety valve limits the ventilation pressure and protects the patient during ventilation with a mask or tube. With COMBIBAG you save time, free up space in your emergency case and save on costs.

CODE	DESCRIPTION
WM11020	Combi Bag Adult/Child



SILICONE RESUSCITATOR

See for yourself how easy it is to use our sturdy silicone resuscitators. They are very easy to clean, disinfect or sterilize. The transparent single-layer silicone bag is available in three sizes – for premature infants and babies up to 20 kg, small children up to 30 kg and adults from 30 kg. Standard delivery includes reservoir bag and corresponding masks. The Weinmann oxygen conservation system OXYMAND demand valve can be connected to the resuscitator with the adapter.

CODE	DESCRIPTION
WM 11101	Silicone Resuscitator Infant
WM1102	Silicone Resuscitator Child
WM11103	Silicone Resuscitator Adult



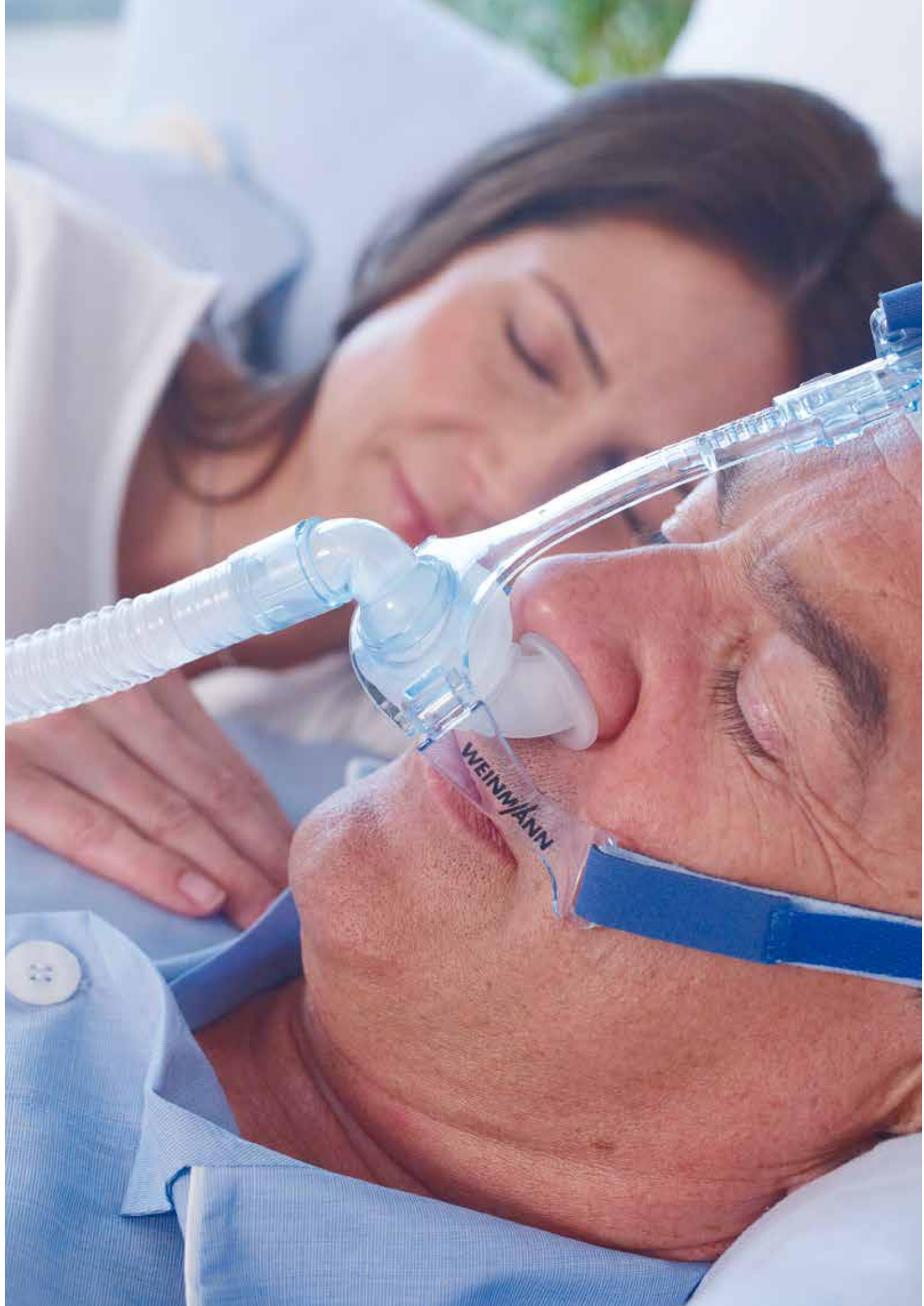

WEINMANN HOMECARE

- SLEEP DIAGNOSTICS
- SLEEP THERAPY
- PATIENT INTERFACE
- OXYGEN MEDICINE



SOMNO CHECK MICRO

For simplified sleep screening at home

SOMNOcheck micro provides reliable sleep screening in a small device that is easy to use and comfortable to wear. The innovative Pulse Wave Analysis (PWA) delivers high-quality differentiated findings. Immediately after the recording has been completed, SOMNOcheck micro shows you the findings in the display. There's no need for a PC or data transmission. The easily understood RAG (Red,Amber, Green) risk assessment in the display is followed by detailed results of the sleep analysis.

Noteworthy features of SOMNOcheck micro:

- Simple and fast identification of patients with an increased risk of Sleep-Disordered Breathing (SDB)
- Differentiated findings for referral to medical specialists
- First small diagnostic device worn on wrist to recognize central apnea / hypopnea
- Findings of SDB based on arousals and RERAs
- Reliable analysis: sensitivity 96.2 %, Specificity 91.7 %)
- Simple Red-Amber-Green function for quick interpretation
- One-key operation: easy access to detailed results
- Reliability assured by automatic analysis of measurements
- Quick and simple documentation on report sheet

CODE	DESCRIPTION
WM9450	Somno Check Micro



SOMNO LAB 2

Superior sleep diagnosis that's mobile, safe and simple

- R&K upgrade set (WM 95235)
- SOMNOlab 2 basic device (WM 95410)
- Data transfer and charging cable (WM 95116)
- Module for galvanic isolator USB/PC(WM 95091)
- USB transmission cable (WM 95076)
- Power supply unit (WM 95090)
- Fixing belt 1.1m (yellow end) (WM 94053)
- Fixing belt 1.50 m (green end) (WM 94054)
- Two (2) connection straps with 40 mm closure (WM 95151)
- Respiratory flow-snore nasal cannula, package of 10 (WM 94044)
- Pneumo-T-Adapter including five (5) hoses (WM 95083)
- Soft-tip sensor SpO2, size L (WM 18035)
- Abdomen sensor loop (WM 95155)
- Fixing belt for abdomen 1.5 m (green end) (WM 94082)
- Fixing belt for abdomen 1.10 m (yellow end) (WM 94083)
- Set of file cards (WM 96502)
- Set of electrodes PG (WM 96501)
- Carrying bag (WM 94055)
- Software SOMNOlab, including instructions for use SOMNOlab 2 (WM 98500)

CODE	DESCRIPTION
WM95400	Somno Lab 2



CPAP 20E - CPAP

Basic therapy for sound sleep

Weinmann's best-priced CPAP 20e guarantees effective CPAP therapy – and thus healthy sleep. User-friendliness and economy are the watchwords for the simple and efficient operating functions.

Features:

- Simple, proven three-button operation
- Trouble-free cleaning
- Quiet, < 30 db(A)
- Light, only 1.25 kg
- Pressure constancy
- Use of standard tube
- Analysis of compliance data with PC software SOMNOsupport
- Date-related compliance data with or without humidifier for 365 days
- Remote setting with SOMNOadjust or SOMNOsupport

Functions

- Softstart function (5 to 30 minutes)
- Two-level filter system
- Safe oxygen feed
- Automatic altitude adjustment
- External power pack can be used worldwide with 100 – 240 V
- DC adapter for 12 V or 24 V available as accessory

Available option - Humidifier CLICK 2

- Attaches to therapy device with a simple "click", holds 280 ml of water, six-level setting on therapy device, easy to clean



SOMNO COMFORT 2E - CPAP

CPAP therapy: Your sleep in top form

SOMNOcomfort 2e is the enhancement of the exceptionally successful SOMNOcomfort device which set the standard for CPAP therapy. The SOMNOcomfort 2e is small, light, extraordinarily quiet and very simple to use, even more so with the new integrated heated humidifier.

An unbeatable duo in top form for greater compliance.

The heated humidifier SOMNOaqua is ideal in many ways for patients who suffer from dried out nasal mucosa.

SOMNOaqua can be inserted easily into the device housing and just as easily removed for cleaning.

Features:

- Pressure constancy for high quality CPAP therapy
- New space-saving device design
- Optional integrated heated humidifier
- Power supply from 100 to 240 V for worldwide use
- Optional DC adapter for mobile use can be connected to 12 V or 24 V
- Patient-friendly three-key operation, including a raised on/off key
- Click adapter for standard hose
- Trouble-free cleaning
- Read-out of compliance data with PC software SOMNOsupport
- Remote settings with SOMNOadjust
- Supplied with trolley-suitable bag

CODE	DESCRIPTION
WM27320	Cpap 20E

CODE	DESCRIPTION
WM29860	Somno Comfort 2E



SOMNO BALANCE E - APAP

Balanced treatment of obstructive sleep apnea

The new auto-CPAP therapy device offers balanced treatment of obstructive sleep apnea. Dependable distinction is made between obstructive and central apnea by the new OPP (Obstructive Pressure Peak) technology. SOMNObalance e is small, light and extremely quiet. The therapy device makes operation very easy and cleaning procedures – thanks to the integrated humidifier SOMNOaqua – absolutely trouble-free.

Features:

- Quiet with good pressure stability
- CPAP and APAP modes available with pressure relief option softPAP
- OPP (Obstructive Pressure Peak) technology to distinguish central from obstructive apnea
- Epoch-based and need-oriented pressure adjustment
- Patient-oriented Info menu in display – therapy success is visualized with RDI (Respiratory Disturbance Index), leakage and 90% percentile
- Extensive statistical data for therapy monitoring (including CPAP) analysis with PC software SOMNOsupport
- Can be used around the world with power pack for 100 to 240 V
- Battery operation (cars: 12 V or trucks: 24 V) possible with optional DC adapter, even with simultaneous operation of SOMNOaqua humidifier
- Suitable for use with full-face masks like JOYCE Full Face



PRISMA 20A - APAP

Therapy flexibility for treatment of Obstructive Sleep Apnea (OSA)

With assistance from Forced Oscillation Technique (FOT), prisma20A reliably distinguishes between obstructive and central apnea. In response to events, the APAP therapy device automatically and continuously adjusts pressure exactly to the needs of your patients. Because the CPAP and APAP modes can be combined with the gentle pressure relief softPAP, prisma20A offers a high degree of therapy flexibility and comfort.

Major features of prisma20A:

- Reliable technology (FOT) distinguishes obstructive sleep apnea from central sleep apnea
- With pressure relief softPAP
- High resolution therapy data for 14 days and detailed statistics for 365 days
- Improved compliance, thanks to comfort functions such as softSTART, autoSTART-STOP and therapy feedback
- Integrated tube heating prevents condensation in tube and mask



The humidifier prismaAQUA is used with a therapy device to treat patients who complain of dry upper airways or cold respiratory air.

CODE	DESCRIPTION
WM27420	Somno Balance E

CODE	DESCRIPTION
WM 29900-1110	Prisma20A
WM 29900-1111	Prisma20A with PrismaAQUA



PRISMA 25S - BILEVEL

BiLevel-S therapy with high/fluctuating pressure needs and CPAP intolerance

Our prisma25S is the device of choice for patients with obstructive, mixed or complex sleep apnea who have high and/or fluctuating pressure needs and show poor CPAP compliance. It offers safe and effective therapy, thanks to adaptive pressure regulation across a broad pressure range, apnea differentiation by means of FOT and process-supporting features. All of that and more - no louder than a soft whisper.

Major features of prisma25S:

- Broad pressure range (4 - 25 hPa) and numerous parameters for greater flexibility with therapy settings
- Safe technology (FOT) distinguishes obstructive from central apnea
- High resolution therapy data for up to 14 days and detailed statistics for 366 days
- Very quiet even at high pressures
- Integrated tube heating prevents condensation in tube and mask



PRISMA 25ST - BILEVEL

BiLevel-ST therapy with innovative setting concept (SCOPES)

You'll receive a therapeutic solution tailored to your personal needs with prisma25ST. Designed for patients with obstructive, mixed or complex sleep apnea with comorbidities, this BiLevel-ST device offers maximum flexibility with settings and indication-specific pre-settings (SCOPES). Furthermore, the automatic backup frequency, apnea differentiation with FOT and many comfort functions ensure safe, effective and whisper-quiet therapy.

Major features of prisma25ST:

- Broad pressure range (4 - 25 hPa) and numerous parameters for greater flexibility with therapy settings
- SCOPES (indication-specific pre-settings) for quick therapeutic success
- Extra safety provided by automatic backup frequency, which can be set to a fixed high rate
- Safe technology (FOT) distinguishes obstructive from central apnea
- Very quiet even at high pressures
- Integrated tube heating prevents condensation in tube and mask functions ensure safe, effective and whisper-quiet therapy



The humidifier prismaAQUA is used with a therapy device to treat patients who complain of dry upper airways or cold respiratory air.



The humidifier prismaAQUA is used with a therapy device to treat patients who complain of dry upper airways or cold respiratory air.

CODE	DESCRIPTION
WM 29900-2110	Prisma25S, BiLevel S Therapy Set
WM 29900-2111	Prisma25S with PrismaAQUA

CODE	DESCRIPTION
WM 29900-2110	Prisma25S, BiLevel S Therapy Set
WM 29900-2111	Prisma25S with PrismaAQUA



PRISMA CR - BILEVEL

The sleep medicine solution for complex Sleep-Disordered Breathing

With prismaCR and its newly validated algorithm, you can reliably treat and provide quick relief to your patients with periodic breathing, e.g., Cheyne-Stokes respiration, and central, mixed or complex breathing disorders. Using intra-breath regulation combined with a backup frequency based on target volume, prismaCR provides pressure support as needed during the patient's current breath.

Major features of prismaCR:

- Validated anticyclic servoventilation (AcSV) with smart adjustment of pressure support within a single breath
- High resolution therapy data for 14 days and detailed statistics for 365 days
- Improved compliance, thanks to comfort functions such as softSTART, autoSTART-STOP and therapy feedback
- Integrated tube heating prevents condensation in tube and mask



PRISMA LAB

The comfortable titration device for all patients

All the modes of the prismaLINE are available to you for titration with prismaLAB. From the computer you can make all mode and pressure changes in prismaLAB to ensure gentle treatment of your patients.

Major features of prismaLAB:

- Equipped with all the modes of the prismaLINE, from CPAP to optimized AcSV (anticyclic servoventilation)
- Uninterrupted therapy and gentle pressure transition when modes change during the night
- High resolution therapy data for 14 days and detailed statistics for 365 days
- Improved compliance, thanks to comfort functions such as softSTART, autoSTART-STOP and therapy feedback
- Integrated tube heating prevents condensation in tube and mask



The humidifier prismaAQUA is used with a therapy device to treat patients who complain of dry upper airways or cold respiratory air.

CODE	DESCRIPTION
WM 29960 -2111	PrismaCR
WM 29960 -2110	PrismaCR with PrismaAQUA

CODE	DESCRIPTION
WM 29989 - 1511	PrismaLAB with PrismaAQUA



VENTIMOTION 2

Noticeably more comfort and stability in non-invasive (NIV) ventilation

You are assured higher quality and more comfort in non-invasive pressure-controlled ventilation by VENTImotion 2. The innovative pressure relief, AirTrap Control, counteracts dynamic hyperinflation. Combined with the trigger lockout function, it makes ventilation easier, especially for COPD patients. VENTImotion 2 also has adjustable volume compensation. With its variable speed settings for the automatic regulation to the target volume, the ventilator ensures optimum safety and stability of tidal volume.

Noteworthy features of VENTImotion 2:

Therapy comfort

- Greater therapy comfort and better ventilation quality, particularly for COPD patients
- AirTrap Control: pressure relief to prevent dynamic hyperinflation
- Trigger lockout: effective protection from false triggering and trigger artefacts
- Variable speeds for pressure rise and pressure fall
- Operating convenience
- Intuitive navigation with rotary push button and direct access to main ventilation parameters
- Numeric and graphic display of ventilation parameters
- Softstart and Autostart
- Compatible with accessories in VENTI line

Safety

- Volume compensation: optimum safety and stability of tidal volume
- Visual and acoustic alarms
- Optional backup power with external rechargeable battery VENTIpowers for up to seven hours of operation
- High flow of up to 300 l/min. for high pressure constancy and leakage compensation
- Hygiene concept for reconditioning at change of patient

CODE	DESCRIPTION
WM27830	Ventimotion 2



VENTILOGIC PLUS

New options for invasive (IV) and non-invasive (NIV) ventilation

No other device in this segment combines therapy efficiency and therapy comfort as effectively and economically as VENTILlogic plus. A slightly leaner version of its “big brother” VENTILlogic LS, VENTILlogic plus is a lower-priced and very efficient therapy device for ventilation treatment at home.

Noteworthy features of VENTILlogic plus:

Therapy comfort

- LIAM (Lung Insufflation Assist Maneuver) cough support
- TA mode (TA = Timed Adaptive): respiratory effort is reduced by the optimized synchronization of device and patient’s breathing pattern
- Trigger lockout: more effective protection from false triggering and trigger artefacts
- Volume compensation: ideal adjustment of therapy pressure to patient needs

Operating convenience

- Intuitive navigation with push-button dial and direct access to main ventilation parameters
- Numeric and graphic display of pressure, flow and volume
- Compatible with accessories in the VENTI line

Safety

- Visual and acoustic alarms
- As dependable as VENTILlogic LS, because VENTILlogic plus also has an integrated rechargeable battery
- Optional backup power supply in external rechargeable battery VENTIpower for up to seven hours of operation
- High flow of up to 300 l/min. for pressure constancy and leakage compensation
- Hygiene concept for reconditioning at change of patient

CODE	DESCRIPTION
WM27980	Ventillogic Plus



VENTI LOGIC LS

The solution for life-support invasive (IV) and non-invasive (NIV) ventilation

VENTIlogic LS ensures complete care of your patients with its combination of NIV and IV options from intermittent ventilation to uninterrupted life-sustaining ventilation. You can use all hose systems – single and double patient circuits with patient valve and leakage hoses – with VENTIlogic LS to cover nearly all indications for invasive ventilation.

Because VENTIlogic LS has all the parameters available in the VENTI line, you can use the therapy device as a titration platform and transfer the parameter settings to all Weinmann ventilators.

VENTIlogic LS features simple and convenient operation and intuitive user navigation. Thanks to the same operating concept and nearly the same design of all VENTI devices, such as VENTIlogic plus, VENTIlogic, VENTImotion 2 and VENTImotion, the entire range of accessories in the Weinmann ventilation product line can also be used for VENTIlogic LS.

Noteworthy features of VENTIlogic LS:

Therapy comfort

- LIAM (Lung Insufflation Assist Maneuver) cough support
- TA mode (TA = Timed Adaptive): reduction in Work of Breathing by ideally synchronizing the device with patient's breathing pattern

- Trigger lockout for effective protection from false triggering and trigger artefacts volume compensation adjustment for optimum match of therapy pressure to patient needs very quiet even at maximum pressure: at 10 hPa, about 28 dB(A)

Operating convenience

- intuitive navigation with push-button dial and direct access to main ventilation parameters
- numeric and graphic presentation of pressure, flow and volume
- storage of emitted alarms for analysis of therapy and device settings
- PC software (WEINMANNsupport) for setting of patient data (WEINMANNadjust) and therapy analysis. Ventilation parameters can be displayed in any conventional PSG system with use of the optional Analogbox D/A.
- compatible with accessories in VENTI line

Safety

- Visual and acoustic alarms
- Internal rechargeable battery supplies power in the event of loss of electrical power
- Optional backup power supply with external rechargeable battery VENTIpower for up to seven hours of operation
- High flow of up to 300 liters/minute. Ensures high pressure constancy and leakage compensation
- Hygiene concept for reconditioning at change of patient

CODE	DESCRIPTION
------	-------------

WM27950	Ventilogic LS
---------	---------------





JOYCEONE - NASAL

Nasal mask for sleep therapy and ventilation that fits nearly every patient

JOYCEone is the nasal mask that always fits. It all happens automatically as the optimized mask cushion finds the ideal position on its own, regardless of the shape and size of the patient's nose. Likewise, the springs on the forehead support automatically maintain the right distance to the forehead for effective and comfortable therapy. JOYCEone also boasts easy handling with color-coded headgear and clips that simplify mask assembly. Taken together, these features help you to save time with fitting and explaining the mask to your patients. The nasal mask JOYCEone is certain to give your patients a good feeling. JOYCEone is also available as a full face mask.

Major features of JOYCEone:

- Time-saving perfect fit: automatic adjustment of mask cushion and forehead support
- Economical: one size fits all patients
- Fool-proof assembly, thanks to color coding of headgear straps and clips
- WEINMANN SilkTec coating increases wearing comfort



JOYCEONE FULL FACE - MASK

Full face mask for sleep therapy and ventilation that fits virtually every patient

JOYCEone Full Face is the full face mask that always fits. The optimized mask cushion automatically finds the ideal position on its own, regardless of the shape and size of the patient's nose. Likewise, the springs on the forehead support automatically maintain the right distance to the forehead for effective and comfortable therapy. JOYCEone Full Face is easy to handle as it is equipped with color-coded headgear and clips that simplify mask assembly. All together, these features help you to save time with fitting and explaining the mask to your patients. The JOYCEone Full Face is certain to give your patients a good feeling. JOYCEone is also available as a nasal mask.

Major features of JOYCEone Full Face:

- The world's first one-size-fits-all full face mask
- Time-saving perfect fit: automatic adjustment of mask cushion and forehead support
- Economical: one size fits all patients
- Fool-proof assembly, thanks to color coding of headgear straps and clips
- WEINMANN SilkTec coating increases wearing comfort

CODE	DESCRIPTION
WM25260	JOYCEONE Nasal

CODE	DESCRIPTION
WM25290	JOYCEONE Mask Full Face



JOYCEEASY - NASAL

Easy-to-use nasal mask for sleep therapy and ventilation

It really could not be easier. Everything about our ventilation mask JOYCEeasy is aimed at easy operation, from the simple mask adjustment directly on the patient to the intuitive handling of the stable nasal mask. Because the improved fit of JOYCEeasy reduces leaking and pressure points to a minimum, patients immediately improve compliance with therapy. JOYCEeasy is also available as a full face mask.

Major features of JOYCEeasy:

- Simple, intuitive handling
- Optimized fit improves therapy compliance
- Even easier size adjustment
- Tube-anchoring strap keeps tube securely in place
- Extremely robust
- WEINMANN SilkTec coating increases wearing comfort



JOYCEEASY FULL FACE - MASK

Easy-to-use full face mask for sleep therapy and ventilation

It really could not be easier. Everything about our ventilation mask JOYCEeasy Full Face is designed for easy operation, from the simple mask adjustment directly on the patient to the intuitive handling of the stable full face mask. The improved fit of JOYCEeasy Full Face reduces leaking and pressure points to a minimum and thus improves patients' therapy compliance. JOYCEeasy is also available as a nasal mask.

Major features of JOYCEeasy Full Face:

- Simple, intuitive handling
- Optimized fit improves therapy compliance
- Even easier size adjustment
- Tube-anchoring strap keeps tube securely in place
- Extremely robust
- WEINMANN SilkTec coating increases wearing comfort
- Quick-release cord to detach mask

CODE	DESCRIPTION
WM12704	JOYCE EASY Nasal - Small
WM12705	JOYCE EASY Nasal - Medium
WM12706	JOYCE EASY Nasal - Large

CODE	DESCRIPTION
WM25910	JOYCE EASY Full Face - Small
WM25920	JOYCE EASY Full Face - Medium
WM25930	JOYCE EASY Full Face- Large



JOYCE NASAL

JOYCE can be assembled specially for each sleep apnea or home mechanical ventilation patient. JOYCE is available in four mask models in four sizes each with two mask seals of different strengths. All these standard masks are available as vented and non-vented variations.

Major features of JOYCE Nasal:

- Proven ball-and-socket joint
- A choice of two mask seals: for low and medium therapy pressure up to 30 hPa; for high therapy pressure of up to 40 hPa
- Optional integrated exhalation system
- Four standard models in four sizes (S, M, L and new: XL) each, packed ready to use
- Mask seal is simply pressed into place with palm of hand
- Extra-small shape
- Extremely quiet
- Anatomically molded, skin-friendly mask seal
- Breathable headgear with practical clip hooks
- Adjustable forehead support, wide cushion
- Stopper for pressure measurement connection



JOYCE FULL FACE MASK

Anatomical fit, convenient handling and a clever concept are all combined in JOYCE Full Face, the mask for sleep apnea and home mechanical ventilation patients. Compared to other full face masks, the small and light JOYCE Full Face guarantees greater wearing comfort. Its modular design principle is also suitable for our nasal mask JOYCE. That helps to optimize inventory management. Fitting the mask to the patient is especially easy and practical with JOYCE Full Face. Simply remove the elbow piece and look into the mask to check the fit.

Major features of JOYCE Full Face:

- Proven ball-and-socket joint
- Anatomical fit for greater wearing comfort
- Easy to fit to patient
- Very quiet
- Lightweight
- Convenient handling (e.g. easily attached to mask seal)

CODE	DESCRIPTION
12113	JOYCE Nasal - Small
12114	JOYCE Nasal - Medium
12115	JOYCE Nasal - Large
12116	JOYCE Nasal - Extra Large

CODE	DESCRIPTION
12117	JOYCE Full Face - Small
12116	JOYCE Full Face - Medium
12112	JOYCE Full Face- Large
12103	JOYCE Full Face- Extra Large



JOYCE SILKGEL

Gel nasal mask with enhanced wearing comfort for sleep therapy and ventilation

The high degree of wearing comfort puts the custom-assembled JOYCE SilkGel mask ahead of the rest. Its gel-filled mask cushion and forehead cushion are coated with the silky smooth WEINMANN SilkTec. The headgear with optimized cut perfectly rounds off the thoroughly comfortable mask. JOYCE SilkGel is also available as a full face mask.

Major features of JOYCE SilkGel:

- Easy to adjust, perfect fit
- WEINMANN SilkTec coating increases wearing comfort
- Simple cleaning because nothing adheres to the smooth surface
- Pressure range from 4 to 40 mbar
- Many replacement parts available
- Ball-and-socket joint provides freedom of movement and a secure fit

CODE	DESCRIPTION
WM12023	JOYCE SILK GEL Nasal - Small
WM12014	JOYCE SILK GEL Nasal - Medium
WM12024	JOYCE SILK GEL Nasal - Large



JOYCE FULL FACE SILKGEL

Gel full face mask with greater wearing comfort for sleep therapy and ventilation

The high degree of wearing comfort puts the custom-assembled JOYCE Full Face SilkGel mask ahead of the rest. Its gel-filled mask cushion and forehead cushion are coated with the silky smooth WEINMANN SilkTec. The headgear with optimized cut perfectly rounds off the thoroughly comfortable mask. JOYCE SilkGel is also available as a nasal mask.

Major features of JOYCE Full Face SilkGel:

- Easy to adjust, perfect fit
- WEINMANN SilkTec coating increases wearing comfort
- Simple cleaning because nothing adheres to the smooth surface
- Pressure range from 4 to 40 mbar
- Many replacement parts available
- Ball-and-socket joint provides freedom of movement and a secure fit
- Quick-release cord to detach mask

CODE	DESCRIPTION
WM12034	JOYCE SILK GEL Full Face - Small
WM12013	JOYCE SILK GEL Full Face - Medium
WM12035	JOYCE SILK GEL Full Face- Large

JOYCE FULL FACE PLUS

The full face mask with the plus in extra chin stability

Secure fit together with greater wearing comfort -those are the features that distinguish JOYCE Full Face, the tried and tested mask for every sleep apnea and home ventilation patient, from the rest. In this model JOYCE Full Face+ works with a two-chamber principle. The first chamber is for the mouth and nose and the second holds the chin as needed. More security results in optimum therapy.

The two-chamber principle:

- The first chamber covers the nose and mouth as does JOYCE Full Face. Consequently we create - as before - minimum dead space.
- The second chamber holds the chin without generating without an unpleasant flow of air across the chin. The lower part of the seal does not lie directly on the chin. If the chin should fall, it will be caught. Air holes prevent sweating.



CODE	DESCRIPTION
12208	JOYCE Full Face Plus - Small
12210	JOYCE Full Face Plus - Medium
12212	JOYCE Full Face Plus - Large



VISIONAIRE OXYGEN CONCENTRATOR

VisionAire™ Oxygen Concentrator with the lowest maintenance costs

Economical and low maintenance are the hallmarks of VisionAire™. Our new oxygen concentrator is a combination of lightweight, compact construction and unique nearly maintenance-free technology. Its intuitive operation and easy transport make VisionAire™ the perfect therapy partner. This concentrator can provide reliable care in keeping with patients' needs throughout the course of the disease.

Major benefits from VisionAire™:

- Nearly maintenance-free, thanks to highly developed technology
- Lightweight at only 13.6 kg
- Small, only 52.8 cm high
- 5-year warranty
- Low power consumption, only 290 watt

CODE	DESCRIPTION
WM13370	WM Visionaire Oxygen Conc.



BONSAI OXYGEN CONSERVER

The Bonsai® is not only the lightest oxygen conserver on the market, it also offers the highest oxygen conservation ratio available! Learn how the Bonsai® can help you save time and money, meet the clinical needs of your patients, and ensure continued customer satisfaction.

CODE	DESCRIPTION
12227	Bonsai OM810 Oxygen Conserverver



OXYGEN REGULATOR

- Body material: aluminum 6061 T6 ,
- All brass internal
- Flow range: 0-8,0-15lpm
- With etched holes in the flow controller to regulate flow
- Barb outlet
- MAX inlet pressure 3,000psi
- Outlet pressure : 50psi
- Dimension:1.38*3.65
- Weight: 273g

CODE	DESCRIPTION
WMME870-S	WM Oxygen Regulator



OXYWAY

Oxygen Pressure Reducer and Flow Regulator

Only a precise dosage of oxygen can achieve the desired effect on your ventilation patients. Our pressure reducers and flow regulators dependably provide extremely precise regulation. OXYWAY Fix, OXYWAY Fine, OXYWAY Fast and OXYWAY Click can be used in many different ways in oxygen and emergency medicine. The ultrasound-tested high-pressure housing and double sinter filter ensure operating safety.

OXYWAY pressure reducers and flow regulators, which we offer in many variants, are available with up to two oxygen outlets – flow and pressure outlets. The flow outlet is for the direct supply of oxygen to the patient while the pressure outlet is for supplying oxygen to the ventilator or oxygen administrator.

Accessories for the OXYWAY pressure reducers and flow regulators include oxygen cylinders and cylinder brackets, oxygen outlets, pressure hoses, administrators, nasal cannula and inhalation masks. With the full range of equipment you ensure a dependable supply of oxygen for use on the road, for extended treatment on the scene or over long transport routes.

Overview of OXYWAY pressure reducers

OXYWAY pressure reducers come in four basic models:

OXYWAY Fast 1

For gradually adjustable doses of oxygen flow in levels 1, 2, 3, 4, 5, 6, 9, 12, 15 liters/minute

OXYWAY Fast 11

For gradually adjustable doses of oxygen flow in levels 0.5, 1, 1.5, 2, 2.5, 3, 4, 5, 6 liters/minute

OXYWAY Fix

For permanently set oxygen flow of 4 liters/minute or of 190 liters/minute for MEDUMAT ventilators.

OXYWAY Fine

For infinitely adjustable oxygen flow of 3 - 15 liters/minute with content and flow meter.

OXYWAY Click

for flow dosage via central gas systems used by rescue services and hospitals.

Each basic device has additional models for special uses. Country-specific connectors are also available upon request.



CODE	DESCRIPTION
12582	WM OXYWAY Fix
12583	WM OXYWAY Fine
12584	WM OXYWAY Fast 1
12585	WM OXYWAY Fast 11
WM31050	WM OXYWAY Click



PROUDLY NZ OWNED

USL has been built by creating seamless relationships. Since 1984 we've built enduring partnerships with customers, suppliers and our community. We set out to create the very best environment for our team so that they might deliver their unique skills to our markets.

WHAT YOU CAN EXPECT FROM US:

- We offer our customers dependability and experience they can rely on and trust.
- We deliver under IFOTIS: In-Full, On-Time, In-Specification.
- We operate a management reporting system that provides information on the frequency, recency, amount and type of purchases for all customers, and thereby enhancing their business purchasing efficiency.
- Normal guarantees apply and are rigorously honoured, and we guarantee to supply our key clients with critical stock items under IFOTIS.
- Our product range is comprehensive. It meets our Healthcare customers' needs, so they can confidently have a one supplier relationship for all medical products.
- Private Market
- General Practitioners
- Nurse Practitioners
- Private Hospitals (Medical, Surgical)
- Rest Homes
- Accident and Emergency Clinics
- Emergency Services
- Occupational Health Services
- Community Trusts
- Physiotherapists and Sports Medicine Clinics
- Sports Clubs and Organising Bodies
- Veterinary Services
- First Aid Suppliers
- Medical Laboratories
- Public Hospitals
- Specialist Clinics
- Community and Public Health Services
- Pharmacy Retail
- Industrial and Safety
- Dermatologists and Skin Clinics

OUR COMPANY AT A GLANCE:

- USL is a limited liability company, proudly New Zealand owned
- Our annual sales exceed \$NZ 60 Million
- Our head office and main distribution centre are based in Auckland
- The South Island is serviced from our Christchurch distribution centre
- We service 3,750 customers at all locations throughout New Zealand including all 20 of the National District Health Board



Order By Freephone:
Auckland: 0800 658 814
Christchurch: 0800 804 546

Order By Freefax:
Auckland: 0800 830 660
Christchurch: 0800 804 547

Auckland Head Office
494 Rosebank Road, Avondale, Auckland 1026
Email: customerservices@uslmedical.co.nz